

USER MANUAL

INALTO

INALTO.HOUSE

Electric Freestanding Cooker

MODEL CODE

RU9EIB



FOR ALL AUSTRALIAN HOMES

V2.0 0623

Welcome

Congratulations on purchasing your new 90cm Freestanding Cooker!

Residentia Group Pty Ltd
ACN. 600 546 656
165 Barkly Avenue
Burnley, Victoria 3121
Australia

—
Applico Ltd
635 Great South Road
Penrose, Auckland 1061
New Zealand

—
InAlto
www.inalto.house
f /inalto.house
@ /inalto.house

The InAlto brand is proudly distributed within Australia by Residentia Group Pty Ltd and within New Zealand by Applico Ltd.

Please refer to the warranty card at the rear of this manual for information regarding your product's parts and labour warranty, or visit online at:

- www.residentia.group
- www.applico.co.nz
- www.inalto.house

Both Residentia Group & Applico are customer obsessed and our Support Teams are there to ensure you get the most out of your appliance. Should you want to learn more about recommended usage, the various features of your appliance, and importantly taking care of the unit when cleaning, our Support Teams are here to help.

Telephone Contacts:

- AU: 1300 11 4357
- NZ: 0800 763 448

It is important that you read through the following use and care manual thoroughly to familiarise yourself with the installation and operation requirements of your appliance to ensure optimum performance.

Again, thank you for choosing an InAlto appliance and we look forward to being of service to you.

SCAN ME



Scan to Register your InAlto Appliance or go to:

- AU: www.inalto.house/registration
- NZ: www.inalto.house/nz/registration

By registering your product, you will receive advanced support, stay updated with the latest from InAlto and find out about new products and promotions.



Contents	Page
Welcome	2
Contents	3
Safety Instructions	4
Before Installing	10
Installation Instructions	11
Your Cooker	16
Your Induction Cooktop	18
Operating the Cooktop	20
Cleaning and Care Cooktop	32
Troubleshooting Cooktop	33
Operating the Oven	36
Cleaning and Care Oven	45
Troubleshooting	51
Tips and Tricks	54
Wiring Diagram	57
Warranty	58

Safety Instructions

This cooker must only be installed in accordance with the instructions provided and by a suitably licensed and qualified installer. Incorrect installation may cause harm to persons, damage property and void the product's warranty.

Important

Please ensure that you read the entire instructions before beginning the installation of your cooker.

Please Note

When the oven is first switched on, it may give off an unpleasant smell. This is due to the bonding agent used for the insulating panels within the oven. This is completely normal, if it does occur, you merely have wait for the smell to clear before putting food into the oven.

- The appliance and its accessible parts become hot during use.
- Care should be taken to avoid touching heating elements.
- Children less than 8 years of age shall be kept away unless continuously supervised.
- This appliance can be used by children aged from 8 years and above and persons with reduced physical, sensory or mental capabilities or lack of experience and knowledge if they have been given supervision or instruction concerning use of the appliance in a safe way and understand the hazards involved. Children shall not play with the appliance. Cleaning and user maintenance shall not be made by children without supervision.
- Do not use harsh abrasive cleaners or sharp metal scrapers to clean the oven door glass since they can scratch the surface, which may result in shattering of the glass.
- The hob surface is of glass-ceramic: if the surface is cracked, switch off the appliance to avoid the possibility of electric shock.
- For the models equipped with a facility to use a temperature 2 sensing probe: Only use the temperature probe recommended for this oven.
- During use, the appliance becomes very hot.
- Care should be taken to avoid touching heating elements inside the oven.

- Do not allow children to go near the oven when it is operating, especially when the grill is on.
- Ensure that the appliance is switched off before replacing the oven lamp to avoid the possibility of electric shock.
- The means for disconnection must be incorporated in the fixed wiring in accordance with the wiring specifications.
- Children should be supervised to ensure that they do not play with the appliance.
- This appliance is not intended for use by persons (including children) with reduced physical, sensory or mental capabilities, or lack of experience and knowledge, unless they have been given supervision or instruction concerning use of the appliance by person responsible for their safety.
- Accessible parts may become hot during use. Young children should be kept away.
- Never use steam cleaners to clean your cooking range
- For models with induction hobs: metallic objects such as knives, forks, spoons and lids should not be placed on the hob surface since they can get hot.
- For models with induction hobs : After use, switch off the hob element by its control and do not rely on the pan detector.
- For the models with a lid: any spillage should be removed from the lid before opening. The hob surface should be allowed to cool before closing the lid.

Warning

The appliance must not be used by people (including children) with or without experience or their safety.

Young children should be supervised to ensure they not play with the limited physical, sensory or mental abilities, expertise, unless they have received instructions for using it from those responsible for appliance.

Safety Instructions (Continued)

Read the instructions for use carefully.
This will enable you to operate your appliance safely and correctly.

This manual is valid for several models. Variations in details for each cooker are possible.

Please keep the instruction manual, installation instructions and the various accessories in a safe place. Please pass on these manuals and accessories to the new owner if you sell the appliance.

Transport damage

Check the appliance for damage after unpacking it. Do not connect the appliance if it has been damaged in transport.

Environmentally-friendly disposal

Dispose of packaging in an environmentally-friendly manner.



This appliance is labelled in accordance with European Directive 2012/19/EU on Waste Electrical and Electronic Equipment WEEE.

Connections

Have a licensed professional carry out the electric connection.
Assembly instructions are supplied with the appliance.

Any damage caused by the appliance being incorrectly connected is not covered under the guarantee. We assume no liability for damage and faults caused by connection and setting errors.

Safety Instructions (Continued)

This appliance is intended for domestic use only. This appliance must only be used for food preparation.

Adults and children must not operate the appliance without supervision if:

- they do not have the physical or mental ability;
- or they lack the knowledge and experience required to operate the appliance safely and correctly.

Never let children play with the appliance.

Never drag, push or move the device once unpacked. The appliance should be lifted and placed in the position desired in order to prevent accidental damage to the floor.

Open the cover plate when the oven is working.

Do not use harsh abrasive cleaners or sharp metal scrapers to clean the oven door glass since they can scratch the surface, which may result in shattering of the glass.

Do not use steam cleaners to clean the appliance.

Hot surfaces

Risk of burns.

Never touch the hob plates, the surfaces of the cooking compartment, the heating elements or the oven steam outlets when they are hot.

Children must be kept at a safe distance from the appliance at all times.

Open the appliance door carefully. Hot steam may escape.

If the hob plates are in operation for a prolonged period, the areas between them can become hot.

Risk of fire.

Never leave flammable objects on the hob or in the storage compartment, or keep them in the cooking compartment.

Risk of short-circuit.

Never trap the mains cable of electrical appliances in the appliance door when it is hot or pull the cable over the hob plates when they are hot. The cable insulation may melt.



Safety Instructions (Continued)

Overheated oil and fat

Risk of fire.

Overheated oil or fat can ignite very quickly. Never leave fat or oil to heat unattended. Should the oil ignite, do not try to put it out by pouring water on it. Cover the pan immediately with a lid or plate. Switch off the hob plate. Allow the cookware to cool down on the hob plate.

High-proof alcohol

Be careful with food that is prepared using drinks with a high alcohol content (e.g. cognac, rum). Alcohol evaporates at high temperatures. In unfavourable circumstances, the alcoholic vapours could catch fire in the appliance.

Risk of burns.

Only use small quantities of drinks with a high alcohol content and open the appliance door carefully.

Repairs

Risk of electrocution.

Incorrect repairs are dangerous. Repairs may only be carried out by one of our experienced after-sales engineers.

Risk of electrocution.

Never replace a damaged power cable yourself. Power cables may only be replaced by one of our experienced after-sales engineers. Switch off the circuit breaker in the fuse box if the appliance is faulty.

Safety Instructions (Continued)

Damage to the hob

Only use the hob plates if cookware is placed on them.

Do not heat empty pots or pans. This will damage the pan base.

Do not allow saucepans to boil dry, in particular enamel and aluminium saucepans.

The pan base must be clean, dry and flat.

With electric hotplates, it is possible that not enough heat is drawn off and the pans become red hot.

Please follow the manufacturer's instructions when using special cookware. Aluminium foil and plastic containers can melt and stick on hot burners.

Do not use a roasting dish which has to be heated using two burners. This will cause heat to accumulate. This could damage the appliance.

Please note that appliances with a hob cover may only be used with the hob cover open.



Safety Instructions (Continued)

Damage to the oven

Never cook meals on the floor of the cooking compartment. Do not leave the baking tray on the cooking compartment floor. Do not cover it with aluminium foil.

Do not place oven or cookware on the oven floor. This will cause heat accumulation. The baking and roasting times will no longer be correct and the enamel will be damaged.

Never pour water directly into a hot oven. This will damage the enamel.

When making very moist fruit flans, do not put too much on the baking tray. Fruit juice dripping from the baking tray leaves stains that cannot be removed.

Do not stand or sit on the open oven door.

Damage to the fronts of adjacent units

Only leave the oven to cool down with the door closed. The fronts of adjacent units may eventually become damaged even if you only leave the oven door open slightly.

If the oven door seal is very dirty, the appliance door will no longer close properly during operation. The fronts of adjacent units will become damaged over time. Keep the seal clean.

Before Installing

This manual is valid for several models. Variations in details for each cooker are possible.

The safe operation of this appliance can only be guaranteed if it has been professionally assembled and installed in accordance with these instructions. The individual who assembled and installed the appliance is liable for damage or faults resulting from incorrect assembly or installation.

All installation and adjustment work, must be undertaken by an authorized expert and carried out in accordance with the currently applicable rules and regulations of the local electricity supply company.

Shut off the supply of electricity before carrying out any work.

Electrical appliances must always be earthed.

If an extractor hood is to be fitted, it must be fitted according to the associated assembly instructions. Ensure that the hood is fitted at least 650 mm clear of the hob.

Before installing

Appliance

Unpacking

Check the condition of the appliance after unpacking it. Do not connect the appliance if it has been damaged in transport.

Dispose of packaging in an environmentally-friendly manner.

Installation Instructions

This appliance is always supplied with a set of adjustable feet and, depending on the model, with a splash guard.

The appliance may also be used without the splash guard.

Fitting the adjustable feet

Beforehand:

- Remove all parts that are not permanently fixed, especially the pan supports and burners.
- Remove the accessories from the oven.

Proceed as follows:

- Tilt the appliance by raising one side slightly from the floor.

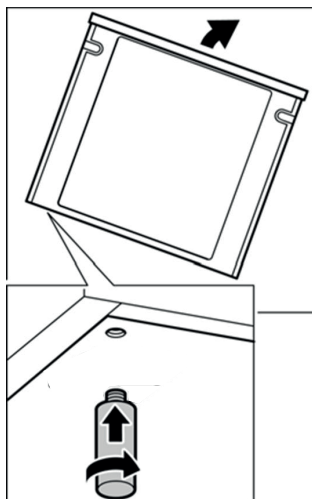

- With the plates in position, screw the adjustable feet into the mounting holes on the underneath of the appliance.
- Repeat the process on the other side.

You can make the final adjustments to the feet in order to level the appliance once the gas and electricity supply have been connected.

If it is necessary to pull the appliance, screw the adjustable feet in fully. Make the final settings only when the other installation tasks have been completed.

Installation Instructions (Continued)

Fitting the splash guard

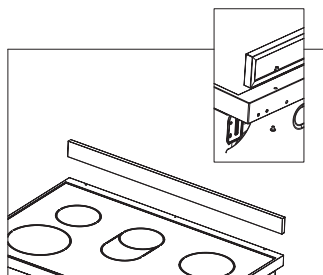

Depending on the model.

Proceed as follows:

- Remove the packaging and the protective film from the splash guard.
- Screw the splash guard onto the rear of the appliance using the 2 bolts, each with a washer, retaining washer and nut.

Positioning and levelling

Positioning the appliance

When installing the appliance, make sure that there is enough space in the final installation location to pull the appliance forwards for cleaning and maintenance work.

The ground underneath must be hard and stable. The wall immediately behind the appliance must be made from non-flammable material, e.g. tiles.

If you need to pull the appliance in order to position it, make sure that the adjustable feet are screwed in fully.

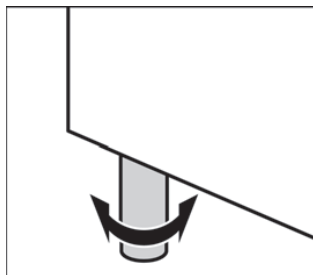

Levelling the appliance

Level the appliance once all other work has been completed.

To do this, turn the adjustable feet.

Installation Instructions (Continued)

- This appliance must be earthed by law. Before connecting the appliance to the electrical supply, check that the earth system in your house is working correctly.
- Check that unit voltage and power, marked on the rating plate applied on the appliance, are correct for the supply. It is necessary that the feeding network is protected by a powerful switch able to disconnect completely the network with a contacts separation of at least 3 mm. Be sure that the earth wire green/yellow is not interrupted by the switch.

WARNING: THIS APPLIANCE MUST BE EARTHED

- In order to avoid hazard, any electrical work performed on this equipment or its associated wiring should only be done by persons authorised by the manufacture or similary qualified persons.

Replacement or mounting of the power cord

The mains cable is replaced via the rear backboard.

The mains cable must be of the following type:

380-415V 3N~	220-240V
H05RR-F	H05RR-F
H05VV-F 5×2.5mm ²	H05VV-F 3×4mm ²
H05RN-F	H05RN-F
H07RN-F	H07RN-F

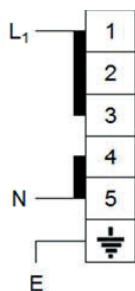
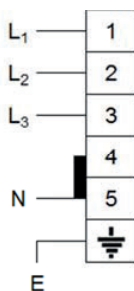

Installation Instructions (Continued)

Leave the mains cable slightly overlong so that you can pull out the appliance for cleaning purposes.

Proceed as follows:

- Remove the rear backboard.
- Undo the screw on the terminal block that fixes the cable in place.
- Loosen the screw contacts and replace the cable with a new one of the same length. The cable must comply with the stipulated specifications.
- Connect the yellow-green wire to the  terminal. This wire must be at least 10 mm longer than the other wires.
- Connect the blue neutral wire to terminal N.
- Connect the brown power wire to terminal L.

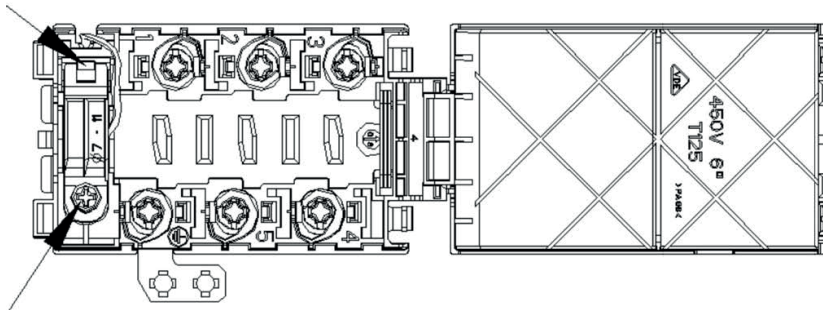

Installation Instructions (Continued)

Stability bracket

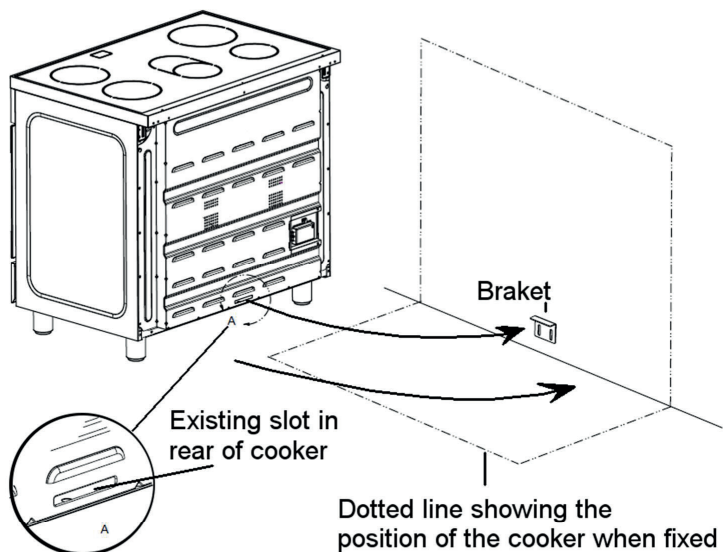

Wall fixing

Installation Instructions (Continued)

INSTALLING THE COOKER AS A BUILT-IN APPLIANCE

IMPORTANT

Kitchen cabinets must be made of materials capable of withstanding temperatures at least 65°C (117°F) above room temperature. This is necessary to avoid possible damage to the cabinets during oven usage.

Note:

- When installing as a built-in appliance, secure it on a raised platform using suitable fastening systems.
- DO NOT install the adjustable feet that come with the appliance.
- DO NOT modify this appliance in any way.

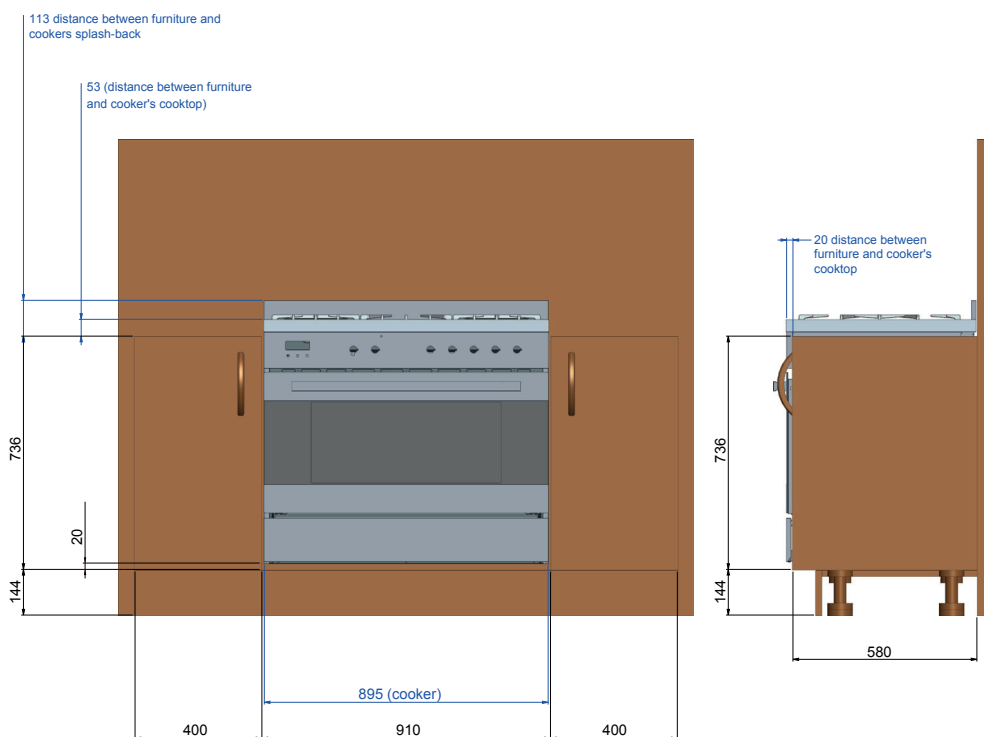



Your Cooker

Appliance dimensions

A=95-160 mm

Note the specified dimensions.

All product outward appearance, the color take the material object as, the picture only supply the reference.

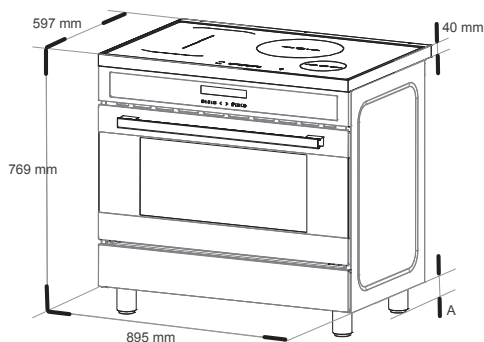

Adjacent units

Adjacent units must be made of non-combustible material. The fronts of adjacent units must be resistant to temperatures up to at least 90 °C. If the appliance is fitted close to other units, the minimum distances specified in the picture must be maintained.

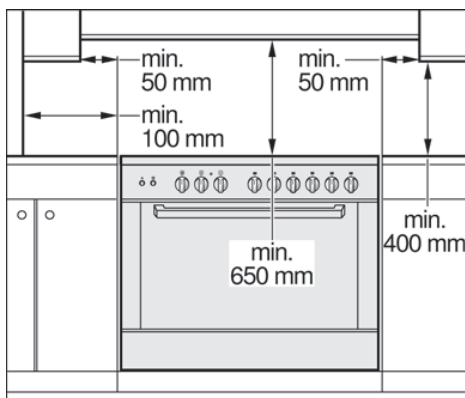

Your Induction Cooktop

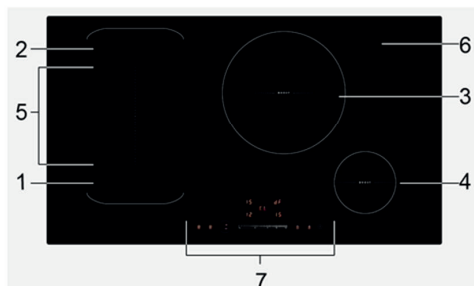

- 1. max. 1800/3000 W zone
- 2. max. 1800/3000 W zone
- 3. max. 3000/4000 W zone
- 4. max. 1400/2000 W zone
- 5. Flexible zone. 3000/4000 W
- 6. Glass plate
- 7. Control panel

Table for for domestic electric hob in according to the Delegated Regulation (UE) n° 65/2014 and Regulation (UE) n° 66/2014 Energy Consumption calculated according to standard EN 60350-2: 2013-07

Identification Model	See rating plate		
Type hob	Cooktop		
Number of zones or areas of cooking		5	
Type of heating system		Induction plate	
Cooking circular zones	3 = 4 =	28,0 15,0	cm cm
Cooking not circular zones	1 L W	20,0 23,0	cm cm
	2 L W	20,0 23,0	cm cm
	5 L W	40,0 23,0	cm cm
Energy consumption per area	EC electric cooking	1 = 210,4 2 = 210,4 3 = 199,7 4 = 189,8 5 = 211,7	Wh/kg Wh/kg Wh/kg Wh/kg Wh/kg
Energy consumption of the hob	EC electric hob	204,4	Wh/kg

HOB TOTAL 7.4 kW
OVEN TOTAL 2.94 kW
Maximum Power 10.34 kW

Voltage
220-240V ~ 50Hz-60Hz
380-415V 3N ~ 50Hz-60Hz



Your Induction Cooktop (Continued)

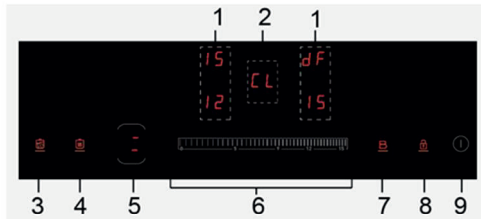

1. Heating zone selection controls
2. Timer control
3. Boiling cue control
4. keep warm control
5. Flexible zone control
6. Power / Timer slider touch control
7. Boost control
8. keylock control
9. ON/OFF control

Operating the Cooktop

A Word on Induction Cooking

Induction cooking is a safe, advanced, efficient, and economical cooking technology. It works by electromagnetic vibrations generating heat directly in the pan, rather than indirectly through heating the glass surface. The glass becomes hot only because the pan eventually warms it up.

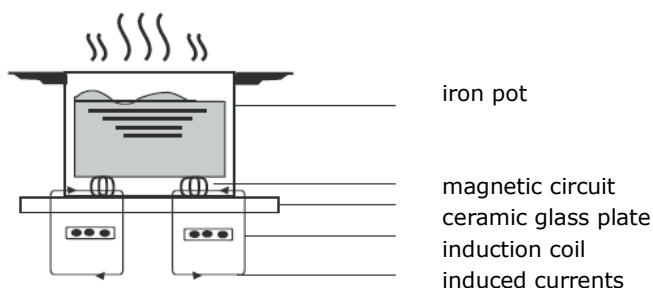

Before using your New Induction Hob

- Read this guide, taking special note of the 'Safety Warnings' section.
- Remove any protective film that may still be on your Induction hob.

Using the Touch Controls

- The controls respond to touch, so you don't need to apply any pressure.
- Use the ball of your finger, not its tip.
- You will hear a beep each time a touch is registered.
- Make sure the controls are always clean, dry, and that there is no object (e.g. a utensil or a cloth) covering them. Even a thin film of water may make the controls difficult to operate.

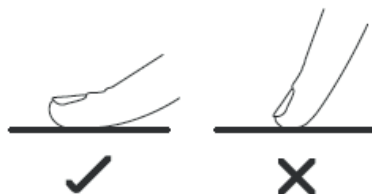

Choosing the right Cookware



- Only use cookware with a base suitable for induction cooking. Look for the induction symbol on the packaging or on the bottom of the pan.



Operating the Cooktop (Continued)

- You can check whether your cookware is suitable by carrying out a magnet test. Move a magnet towards the base of the pan. If it is attracted, the pan is suitable for induction.
- If you do not have a magnet:
 1. Put some water in the pan you want to check.
 2. Follow the steps under 'To start cooking'.
 3. If does not flash in the display and the water is heating, the pan is suitable.
- Cookware made from the following materials is not suitable: pure stainless steel, aluminium or copper without a magnetic base, glass, wood, porcelain, ceramic, and earthenware.

Do not use cookware with jagged edges or a curved base.



Make sure that the base of your pan is smooth, sits flat against the glass, and is the same size as the cooking zone. Use pans whose diameter is as large as the graphic of the zone selected. Using a pot a slightly wider energy will be used at its maximum efficiency. If you use smaller pot efficiency could be less than expected. Pot less than 140 mm could be undetected by the hob. Always centre your pan on the cooking zone.

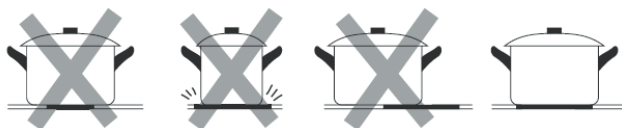

Always lift pans off the Induction hob – do not slide, or they may scratch the glass.

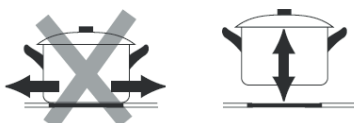

Pan Dimension

The cooking zones are, up to a limit, automatically adapted to the diameter of the pan. However the bottom of this pan must have a minimum of diameter according to the corresponding cooking zone. To obtain the best efficiency of your hob, please place the pan in the centre of the cooking zone.

Operating the Cooktop (Continued)

Cooking zone	The base diameter of induction cookware	
	Minimum (mm)	Maximum (mm)
1,2,	140	220
3	220	300
4	120	160
Flexible zone	220	220x400

Using your Induction Hob To start cooking

1. Touch the ON/OFF control.
After power on, the timer beeps once, timer control show " CL ", heating zone selection controls show " 00, indicating that the induction hob has entered the state of standby mode.
2. Place a suitable pan on the cooking zone that you wish to use.
 - Make sure the bottom of the pan and the surface of the cooking zone are clean and dry.

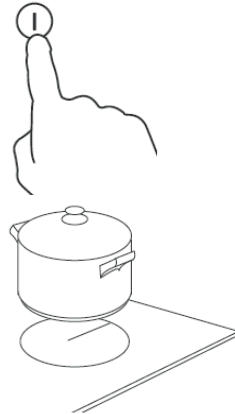

3. Touching the heating zone selection control, and a indicator where you touched will flash



4. Adjust heat setting by touching the slider control.

- If you don't choose a heat setting within 1 minute, the Induction hob will automatically switch off. You will need to start again at step 1.
- You can modify the heat setting at any time during cooking.

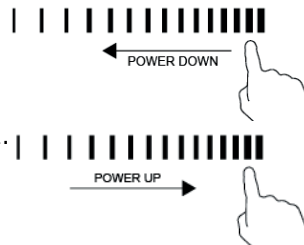

If the display flashes alternately with the heat setting

This means that:

Operating the Cooktop (Continued)

- you have not placed a pan on the correct cooking zone or,
- the pan you're using is not suitable for induction cooking or,
- the pan is too small or not properly centred on the cooking zone.

No heating takes place unless there is a suitable pan on the cooking zone. The display will automatically turn off after 1 minute if no suitable pan is placed on it.

When you have finished cooking

1. Touching the heating zone selection control that you wish to switch off
2. Turn the cooking zone off by touching the slider to the left. Make sure the display shows "0"
3. Turn the whole cooktop off by touching the ON/OFF control.

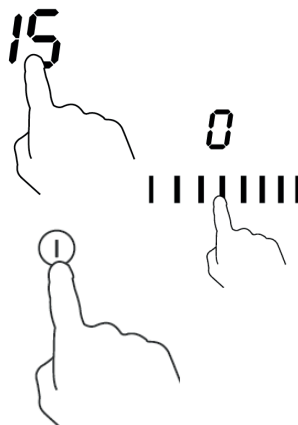

4. Beware of hot surfaces

H will show which cooking zone is hot to touch. It will disappear when the surface has cooled down to a safe temperature. It can also be used as an energy saving function if you want to heat further pans, use the hotplate that is still hot.

H

Using the Boost function

Activated the boost function

1. Touching the heating zone selection control
2. Touching the boost control **B** the zone indicator show "b" and the power reach Max.

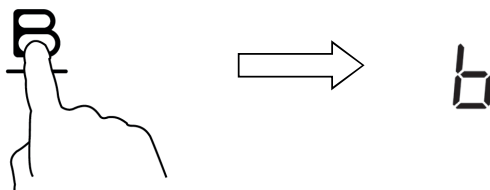

Operating the Cooktop (Continued)

Cancel the Boost function

1. Touching the heating zone selection control that you wish to cancel the boost function
2. a: Touching the boost control "B", then the cooking zone will revert to its original setting.
b: Touching the slider control, then the cooking zone will revert to the level you select.

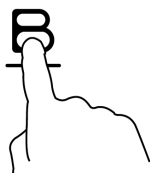
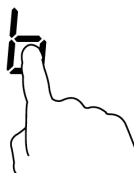

OR



- The function can work in all cooking zones
- The cooking zone returns to its original setting after 5 minutes.
- As the boost function of 1st cooking zone is activated ,the 2nd cooking zone is limited under level 2 automatically. vice versa
- If the original heat setting equals 0, it will return to 15 after 5 minutes.

Using the Keep Warm function

Activated the keep warm function

1. Touching the heating zone selection control
2. Touching the keep warm control  the zone indicator show "1".

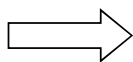
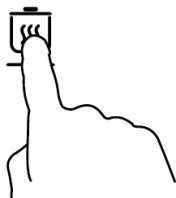
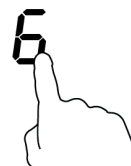

Cancel the keep warm function

1. Touching the heating zone selection control



Operating the Cooktop (Continued)

2. a: Touching the slider control, then the cooking zone will revert to the level you select.



- b: Touching the function control such as  or **B** then the cooking zone will revert to you select.

FLEXIBLE AREA

- This area can be used as a single zone or as two different zones, accordingly to the cooking needs anytime.
- Flexible area is made of two independent inductors that can be controlled separately. When working as a single zone, a cookware is moved from one zone to the other one within the flexible area keeping the same power level of the zone where the cookware originally was placed, and the part that is not covered by cookware is automatically switched off.
- **Important:** Make sure to place the cookwares centered on the single cooking zone. In case of big pot, oval, rectangular and elongated pans make sure to place the pans centered on the cooking zone covering both logos. Examples of good pot placement and bad placement.

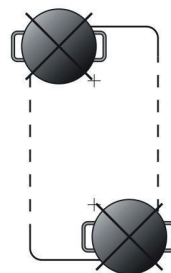
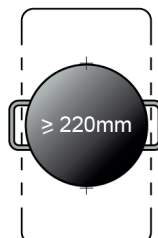
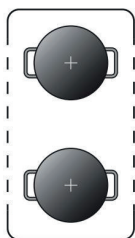

As big zone

1. To activate the flexible area as a single big zone, simply press the dedicated keys.
2. The power setting works as any other normal area.
3. If the pot is moved from the front to the rear part (or



Operating the Cooktop (Continued)

viceversa), the flexible area detects automatically the new position, keeping the same power.

- To add a further pot, press again the dedicated keys, in order to detect the cookware.

As two independent zones

To use the flexible area as two different zones with different power settings, press the dedicated keys.

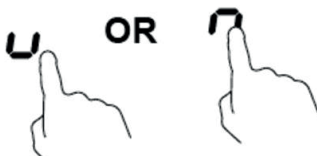

Locking the Controls

- You can lock the controls to prevent unintended use (for example children accidentally turning the cooking zones on).
- When the controls are locked, all the controls except the ON/OFF control are disabled.

To lock the controls

Touch the keylock  control. The timer indicator will show "Lo "

To unlock the controls

- Make sure the Induction hob is turned on.
- Touch and hold the keylock control  for a while.
- You can now start using your Induction hob.



When the hob is in the lock mode, all the controls are disabled except the ON/OFF, you can always turn the induction hob off with the ON/OFF control in an emergency, but you shall unlock the hob first in the next operation

Over-Temperature Protection

A temperature sensor equipped can monitor the temperature inside the Induction hob. When an excessive temperature is monitored, the Induction hob will stop operation automatically.

Detection of Small Articles

When an unsuitable size or non-magnetic pan (e.g. aluminium), or some other small item (e.g. knife, fork, key) has been left on the hob, the hob automatically goes on to standby in 1 minute. The fan will keep cooling down the induction hob for a further 1 minute.

Operating the Cooktop (Continued)

Auto Shutdown Protection

Auto shut down is a safety protection function for your induction hob. It shut down automatically if ever you forget to turn off your cooking. The default working times for various power levels are shown in the below table: .

Power level	Keep warm	1~5	6~10	11~14	15
Default working timer (hour)	2	8	4	2	1

When the pot is removed, the induction hob can stop heating immediately and the hob automatically switch off after 2 minutes.



People with a heart pace maker should consult with their doctor before using this unit.

Using the Timer

You can use the timer in two different ways:

- You can use it as a minute minder. In this case, the timer will not turn any cooking zone off when the set time is up.
- You can set it to turn cooking zones off after the set time is up.
- You can set the timer for up to 99 minutes.

Operating the Cooktop (Continued)

Setting the timer to turn cooking zones off

If the timer is set on one zone:

1. Touching the heating zone selection control that you want to set the timer for.
2. Touch timer control , the "10" will show in the timer display. and the "0" flashes.
3. Set the time by touching the slider control. (e.g. 6)
4. Touch timer control again, the "1" will flash.
5. set the time by touching the slider control (e.g.9), now the timer you set is 96 minutes.
6. When the time is set, it will begin to count down immediately. The display will show the remaining time and the timer indicator flash for 5 seconds.

NOTE: The red dot next to power level indicator will illuminate indicating that zone is selected.

7. When cooking timer expires, the corresponding cooking zone will be switch off automatically.

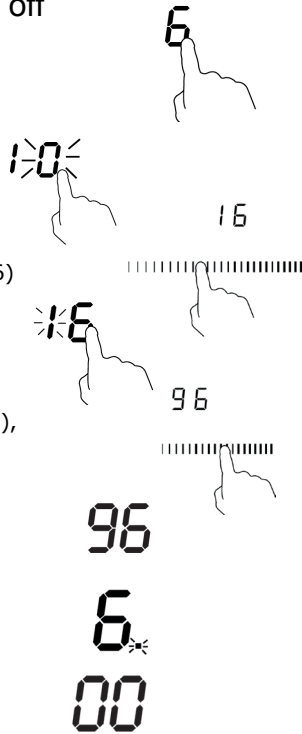

Other cooking zone will keep operating if they are turned on previously.

If the timer is set on more than one zone:

1. When you set the time for several cooking zones simultaneously, decimal dots of the relevant cooking zones are on. The minute display shows the min. timer. The dot of the corresponding zone flashes.





Operating the Cooktop (Continued)

15

(set to 15 minutes)

(set to 45 minutes)

- 2. Once the countdown timer expires, the corresponding zone will switch off. Then it will show the new min. timer and the dot of corresponding zone will flash.

30

6

- Touch the heating zone selection control, the corresponding timer will be shown in the timer indicator.

Using the boiling cue control

You can use the function to boil water and it will remind you of the boiling water.

Activated the boiling cue function

- 1. Touching the heating zone selection control

6

- 2. Touching the boiling cue control  the zone indicator show "2L".

Touching the boiling cue control  again, the zone indicator show "3L".

Touching the boiling cue control  for the third time, the zone indicator show "5L".

Touching the boiling cue control  for the fourth time, the zone indicator show "0".

Cancel the boiling cue function

- 1. Touching the heating zone selection control

3L

- 2. a: Touching the slider control, then the cooking zone will revert to the level you select.



- b: Touching the function control  then the cooking zone will revert to you select.

- It is important that the water temperature is neither too hot nor too cold when

Operating the Cooktop (Continued)

cooking begins, as this could affect the final result.

- Once the water has boiled, a series of beeps is heard and the zone indicator flashes. Then give a short press on the boiling cue control  Power 9 is displayed by default.
- The function can only work in 3rd cooking zone.
- Use pans whose diameter is as large as the graphic of the zone selected.
- Do not use cast iron cookware.
- Do not use a lid.
- As the boost function of 3rd cooking zone is activated, the 4th cooking zone is limited.

Cooking Guidelines



Take care when frying as the oil and fat heat up very quickly, particularly if you're using PowerBoost. At extremely high temperatures oil and fat will ignite spontaneously and this presents a serious fire risk.

Cooking Tips

- When food comes to the boil, reduce the temperature setting.
- Using a lid will reduce cooking times and save energy by retaining the heat.
- Minimise the amount of liquid or fat to reduce cooking times.
- Start cooking on a high setting and reduce the setting when the food has heated through.

Simmering, cooking rice

- Simmering occurs below boiling point, at around 85°C, when bubbles are just rising occasionally to the surface of the cooking liquid. It is the key to delicious soups and tender stews because the flavours develop without overcooking the food. You should also cook egg-based and flourthickened sauces below boiling point.
- Some tasks, including cooking rice by the absorption method, may require a setting higher than the lowest setting to ensure the food is cooked properly in the time recommended.

Searing steak

To cook juicy flavoursome steaks:

1. Stand the meat at room temperature for about 20 minutes before cooking.
2. Heat up a heavy-based frying pan.
3. Brush both sides of the steak with oil. Drizzle a small amount of oil into the hot pan and then lower the meat onto the hot pan.
4. Turn the steak only once during cooking. The exact cooking time will depend on the thickness of the steak and how cooked you want it. Times may vary from

Operating the Cooktop (Continued)

about 2 – 8 minutes per side. Press the steak to gauge how cooked it is – the firmer it feels the more ‘well done’ it will be.

5. Leave the steak to rest on a warm plate for a few minutes to allow it to relax and become tender before serving.

For stir-frying

1. Choose an induction compatible flat-based wok or a large frying pan.
2. Have all the ingredients and equipment ready. Stir-frying should be quick. If cooking large quantities, cook the food in several smaller batches.
3. Preheat the pan briefly and add two tablespoons of oil.
4. Cook any meat first, put it aside and keep warm.
5. Stir-fry the vegetables. When they are hot but still crisp, turn the cooking zone to a lower setting, return the meat to the pan and add your sauce.
6. Stir the ingredients gently to make sure they are heated through.
7. Serve immediately.

Heat Settings

The settings below are guidelines only. The exact setting will depend on several factors, including your cookware and the amount you are cooking. Experiment with the induction hob to find the settings that best suit you.

Heat setting	Suitability
1 - 2	<ul style="list-style-type: none"> • delicate warming for small amounts of food • melting chocolate, butter, and foods that burn quickly • gentle simmering • slow warming
3 - 5	<ul style="list-style-type: none"> • reheating • rapid simmering • cooking rice
6 - 11	<ul style="list-style-type: none"> • pancakes
12 - 14	<ul style="list-style-type: none"> • sautéing • cooking pasta
15/P	<ul style="list-style-type: none"> • stir-frying • searing • bringing soup to the boil • boiling water

Cleaning and Care

The settings below are guidelines only. The exact setting will depend on several factors, including your cookware and the amount you are cooking. Experiment with the cooktop to find the settings that best suit you.

What?	How?	Important!
Everyday soiling on glass (fingerprints, marks, stains left by food or non-sugary spillovers on the glass)	<ol style="list-style-type: none"> 1. Switch the power to the cooktop off. 2. Apply a cooktop cleaner while the glass is still warm (but not hot!) 3. Rinse and wipe dry with a clean cloth or paper towel. 4. Switch the power to the cooktop back on. 	<ul style="list-style-type: none"> • When the power to the cooktop is switched off, there will be no 'hot surface' indication but the cooking zone may still be hot! Take extreme care. • Heavy-duty scourers, some nylon scourers and harsh/abrasive cleaning agents may scratch the glass. Always read the label to check if your cleaner or scourer is suitable. • Never leave cleaning residue on the cooktop: the glass may become stained.
Boilovers, melts, and hot sugary spills on the glass	Remove these immediately with a fish slice, palette knife or razor blade scraper suitable for Induction glass cooktops, but beware of hot cooking zone surfaces: <ol style="list-style-type: none"> 1. Switch the power to the cooktop off at the wall. 2. Hold the blade or utensil at a 30° angle and scrape the soiling or spill to a cool area of the cooktop. 3. Clean the soiling or spill up with a dish cloth or paper towel. 4. Follow steps 2 to 4 for 'Everyday soiling on glass' above. 	<ul style="list-style-type: none"> • Remove stains left by melts and sugary food or spillovers as soon as possible. If left to cool on the glass, they may be difficult to remove or even permanently damage the glass surface. • Cut hazard: when the safety cover is retracted, the blade in a scraper is razor-sharp. Use with extreme care and always store safely and out of reach of children.
Spillovers on the touch controls	<ol style="list-style-type: none"> 1. Switch the power to the cooktop off. 2. Soak up the spill 3. Wipe the touch control area with a clean damp sponge or cloth. 4. Wipe the area completely dry with a paper towel. 5. Switch the power to the cooktop back on. 	<ul style="list-style-type: none"> • The cooktop may beep and turn itself off, and the touch controls may not function while there is liquid on them. Make sure you wipe the touch control area dry before turning the cooktop back on.



Troubleshooting

Problem	Possible causes	What to do
The induction hob cannot be turned on.	No power.	Make sure the induction hob is connected to the power supply and that it is switched on. Check whether there is a power outage in your home or area. If you've checked everything and the problem persists, call a qualified technician.
The touch controls are unresponsive.	The controls are locked.	Unlock the controls. See section 'Using your induction cooktop' for instructions.
The touch controls are difficult to operate.	There may be a slight film of water over the controls or you may be using the tip of your finger when touching the controls.	Make sure the touch control area is dry and use the ball of your finger when touching the controls.
The glass is being scratched.	Rough-edged cookware. Unsuitable, abrasive scourer or cleaning products being used.	Use cookware with flat and smooth bases. See 'Choosing the right cookware'. See 'Care and cleaning'.
Some pans make crackling or clicking noises.	This may be caused by the construction of your cookware (layers of different metals vibrating differently).	This is normal for cookware and does not indicate a fault.
The induction hob makes a low humming noise when used on a high heat setting.	This is caused by the technology of induction cooking.	This is normal, but the noise should quieten down or disappear completely when you decrease the heat setting.
Fan noise coming from the induction hob.	A cooling fan built into your induction hob has come on to prevent the electronics from overheating. It may continue to run even after you've turned the induction hob off.	This is normal and needs no action. Do not switch the power to the induction hob off at the wall while the fan is running.

Troubleshooting (Continued)

<p>Pans do not become hot and appears in the display.</p>	<p>The induction hob cannot detect the pan because it is not suitable for induction cooking.</p> <p>The induction hob cannot detect the pan because it is too small for the cooking zone or not properly centred on it.</p>	<p>Use cookware suitable for induction cooking. See section 'Choosing the right cookware'.</p> <p>Centre the pan and make sure that its base matches the size of the cooking zone.</p>
<p>The induction hob or a cooking zone has turned itself off unexpectedly, a tone sounds and an error code is displayed (typically alternating with one or two digits in the cooking timer display).</p>	<p>Technical fault.</p>	<p>Please note down the error letters and numbers, switch the power to the induction hob off at the wall, and contact a qualified technician.</p>

Failure Display and Inspection

If an abnormality comes up, the induction hob will enter the protective state automatically and display corresponding protective codes:

Problem	Possible causes	What to do
F1-F6	Temperature sensor failure	Please contact the supplier.
F9-FA	Temperature sensor of the IGBT failure.	Please contact the supplier.
FC	The connection between the display board and the main board is fail	Please contact the supplier.
E1/E2	Abnormal supply voltage	Please inspect whether power supply is normal. Power on after the power supply is normal.
E3/E4	Temperature sensor of the ceramic glass plate Is high	Please restart after the induction hob cools down.
E5	Temperature sensor of the IGBT Is high	Please restart after the induction hob cools down.

if there are anyone zone of the flexible area to be protected, the flexible area selection control will not be able to use.

The above are the judgment and inspection of common failures.

Please do not disassemble the unit by yourself to avoid any dangers and damages to the induction hob.



THIS PAGE IS INTENTIONALLY LEFT BLANK

Operating the Oven

Electronic control

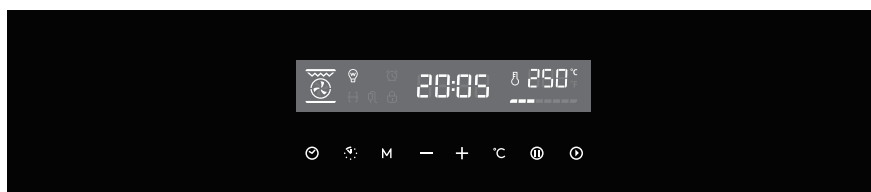

Symbol	Function description
	Oven Lamp: Which enables the user to observe the progress of cooking without opening the door. Oven lamp will light for all cooking functions.
	Defrost: The circulation of air at room temperature enables quicker thawing of frozen food, (without the use of any heat). It's a gentle but quick way to speed up the defrosting time and thawing of ready-made dishes and cream filled produce etc.
	Bottom heater: A concealed element in the bottom of the oven provides a more concentrative heat to the base of food without browning. This is ideal for slow cooking dishes such as casseroles, stews, pastries and pizzas where a crispy base is desired. The temperature can be set within the range of 60-120°C. The default temperature is 60°C.
	Conventional cooking: The top and bottom work together to provide convectional cooking. The temperature can be set within the range of 50-250°C. The default temperature is 220°C.
	Convection with fan: Combination of the fan and both heating element provides more even heat penetration, saving up to 30-40% of energy. Dishes are lightly browned on the outside and still moist on the inside. Note: This function is suitable for grilling or roasting big pieces of meat at a higher temperature. The temperature can be set within the range of 50-250°C. The default temperature is 220°C.
	Radiant grilling: The inner grill element switches on and off to maintain temperature. The temperature can be set within the range of 180-240°C. The default temperature is 210°C. This is optional function that can be work with rotisserie motor.
	Double grilling: The inside radiant element and top element are working. The temperature can be set within the range of 180-240°C. The default temperature is 210°C. This is optional function that can be work with rotisserie motor.
	Double grilling with fan: The inside radiant element and top element are working with fan. The temperature can be set within the range of 180-240°C. The default temperature is 210°C. This is optional function that can be work with rotisserie motor.
	Convection: An element around the convection fan provides an additional source of heat for convection style cooking. In convection mode the fan automatically comes on to improve air circulation within the oven and creates an even heat for cooking. The temperature can be set within the range of 50-240°C. The default temperature is 180°C.

Operating the Oven (Continued)

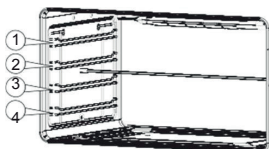

Oven Accessories



The accessories can be inserted in the oven in 4 different shelf positions.

You can pull the accessories two-thirds of the way out without them tipping. This allows meals to be removed easily.

You can buy accessories from the after-sales service or from specialist retailers.

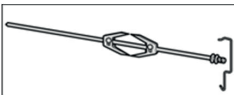



Accessory	Description
	Baking and roasting shelf For ovenware, cake tins, roasts, grilling and frozen meals.
	Enamelled baking tray For moist cakes, pastries, frozen meals and large roasts. Can also be inserted underneath the wire rack or rotary spit and used as a drip tray to collect fat.
	Rotary spit For roasts and large pieces of poultry. Use only in combination with the enamelled baking tray.

Using the electronic oven control

OPERATION INSTRUCTIONS





1. Clock Setting

After connecting the unit to the power, the symbols "0:00" will be visible on the display.

- 1> Press "", the hour figures will flash.
- 2> Press "" to adjust the hour figures, (time should be within 0--23).
- 3> Press "", the minutes will flash.
- 4> Press "" to adjust the minutes setting, (time should be within 0-- 9).
- 5> Press "" to finish the clock settings. ":" will flash, and the time will be illuminated.

Note: The clock is 24 hours. After power on, if not set, the clock will show "0:00".

2. Function Setting

- 1> Press "" to choose the cooking function you require. The related indicator will illuminated .
- 2> Press "" to adjust the cooking time and adjust the temperature before press "" to switch .
- 3> Press "" to confirm the start of cooking.
- 4> If step 2 is ignored, Press "" to confirm the start of cooking and the default time is 9 hours, the default temperature will display on the LCD.

Operating the Oven (Continued)

NOTE:

1>The step quantities for the adjustment time of the coding switch are as follow:

0--0:30min: step 1 minute 0:30--9:00hour :step 5 minutes

2>The step quantities for the adjustment of temperature is 5°C, and "⊖" "⊕" can not adjust the temperature.

3>Press "<>" to adjust the cooking time when cooking begins. Then press "⏸" to confirm.

If "⏸" not pressed within 5 seconds,the oven will revert back to the previous time to continue cooking.

4>Press "⊖", the "⊖" will show, then press"<>" to adjust the temperature when cooking begins.

Then press" ⏸ " to start cooking. If "⏸" not pressed in 5 seconds, the oven will revert back to the previous temperatruue to continue cooking.

3.Lamp Setting

1> Press "F" to select the relevant function, then the corresponding icon will be on.

2> Press "⏸" button to start, "0:00" and lamp icon "⏸" will light up, ":" will flash.

4.Inquiring function

In the following states, you can use inquiring function, after 3 seconds return to the current state.

1> During working state, if the clock was set, press "⌚" button to see the current time; if the reminder function was set, press "⌘" button to see the time of reminder.

2> In reminding state, if the clock was set, press "⌚" button to see the current time.

5. Child lock function

To Lock : press "⏸" and "⏸" simultaneously for 3 seconds, there will be a long "beeping" sound and the "⏸" will be illuminated.

Lock quitting : press "⏸" and "⏸" simultaneously for 3 seconds, there will be a long "beeping" sound indicating the child-lock is released.

Note: During working mode, if you want to stop cooking,press stop button quickly. Do not need to long pressing on stop button,it is invalid.

6. Reminder Function:

The oven has 9 hours reminder, this function will help to remind you to start cooking in a certain time from 1 minute to 9 hours. Only when oven in standby mode, the reminder can be set. Follow below to set the reminder:

1> Press reminder setting button "⌘" and the display shows "⌚" and "AL";

2> Press "<>" to set the time of reminder.

3> Press "⏸" to confirm setting. ":" will be flash and the indicator for reminder "⌚" will light.The time will count down.

Note: The oven buzzer will sound for 10 times after the time back to the zero hour. "⌚" symbol disappears on the screen to remind you to start cooking. You can cancel the reminder during setting by pressing the stop button; After the reminder has been set, you can cancel it by pressing stop button twice.

7. Start/Pause/Cancel Function

1> If the cooking time has been set, press "⏸" to start cooking. If the cooking is paused, press "⏸" to resume cooking.

2> During cooking process, press "⏸" once to pause the cooking. Press "⏸" twice to cancel the cooking.



Operating the Oven (Continued)

8. Energy-Saving Function

- 1> In waiting state and reminding state , press "  " for three seconds, the LCD display will go off and set to energy-saving mode.
- 2> If no operation in 10 minutes under waiting state, the LCD display will go off and go into energy-saving mode.
- 3> Under the energy-saving mode, press any key can quit the energy-saving mode.

9. Note

- 1> The oven lamp will be on for all functions.
- 2> Once the cooking programme has been set and the "  " button is not pressed within 5 minutes, the current time will be displayed or turn back to waiting state. The setting program will be invalid.
- 3> The buzzer will sound once when effectively pressed, if not effectively pressed there will be no response.
- 4> The buzzer will sound five times to remind you when cooking has finished.

Operating the Oven (Continued)

The storage compartment

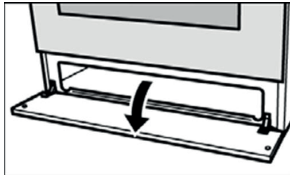

Open the storage compartment by folding down the fascia panel.

This compartment can be used to store hob or oven accessories.

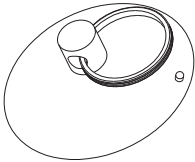

There is a plastic sucker in some models can help you open the drawer.

Risk of fire.

Never leave combustible items in the storage compartment.

Operating the Oven (Continued)

Please read the following instructions before using your appliance for the first time.
Remove the appliance packaging and dispose of this appropriately.

Baking out the oven

Cooking compartment initial cleaning

Remove the accessories from the cooking compartment.



Completely remove any leftover packaging, e.g. small pieces of polystyrene, from the cooking compartment.

Some parts are covered with a protective film. Remove this film.

1. Clean the outside of the appliance with a soft, damp cloth.
2. If the hook-in racks have already been fitted, unhook and remove them. For information on removing the racks, see the section "Removing and refitting hook-in racks."
3. Clean the cooking compartment with warm soapy water.

Heating up the oven (according to the model)

To remove the new cooker smell, heat up the oven when it is empty and closed.

1. Put the switch in position  conventional cooking
Set the thermostat to 200 ° C
2. After 25 minutes, switch the oven off by turning the control knob clockwise to position 0 .
1. Put the switch in position  fan assisted multilevel oven
Set the thermostat to 200 ° C
2. After 25 minutes, switch the oven off by turning the control knob clockwise to position 0 .

Operating the Oven (Continued)

Heating up the grill

- 1 Put the switch in position grill 
- 2 After 25 minutes, switch the oven off by turning the control knob clockwise to position 0 .

Rinsing cooking compartment after initial cleaning

Clean the cooking compartment with hot soapy water. Refit the hook-in racks.

gas lighter or a match.

Using the rotary spit

The rotary spit can be used to cook joints such as rolled joints and poultry with excellent results. The meat is roasted thoroughly and evenly.

The rotary spit function only when the switch is in position grill.

Preparing joints

Place the joint as centrally as possible on the rotary spit and secure it at both ends with the retaining clips.

You can also truss the joint with string. With poultry, bind the ends of the wings underneath the back and the thighs against the body. This will prevent them from becoming too dark.

Pierce the skin on the underside of the wings to allow the fat to escape.

Operating the Oven (Continued)

Inserting the rotary spit

Insert the rotary spit as follows:

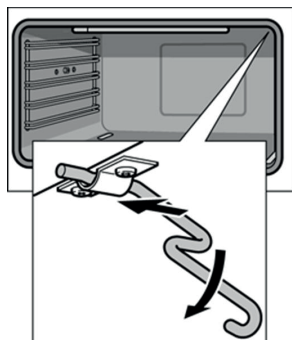

1. Hook the spit holder into the bracket on the ceiling of the cooking compartment.
If you require to preheat the oven, hook in the holder before preheating.

Risk of burns

Never touch the hot surfaces of the cooking compartment or the heating elements.
Children must be kept at a safe distance from the appliance at all times.
Open the appliance door carefully. Hot steam may escape.

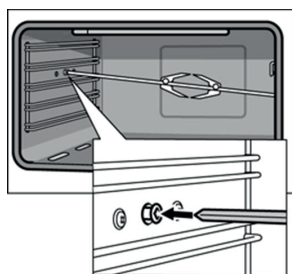

2. If the oven has been preheated, only attach the rotary spit if you are using an oven cloth or wearing (thermal) oven gloves. To attach the spit, slide one end into the recessed adapter in the left-hand side panel of the cooking compartment.

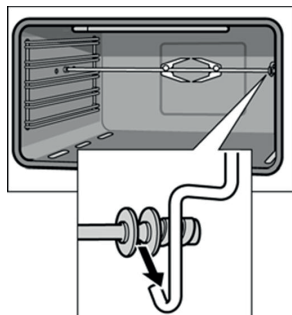

3. Hook the other end into the holder.
4. Pour a little bit of water into the baking tray and slide this into shelf position 1 to collect the run-off fat.

Operating the Oven (Continued)

Removing the rotary spit

Risk of burns.

Never touch the hot surfaces of the cooking compartment or the heating elements.

Children must be kept at a safe distance from the appliance at all times.

Open the appliance door carefully. Hot steam may escape.

Risk of burns.

Never touch the rotary spit or other accessories directly when they are hot.

Always wear oven gloves or heat-resistant gloves when handling hot accessories.

Remove the rotary spit as follows:

1. Carefully open the appliance door. Carefully remove the rotary spit from the holder.

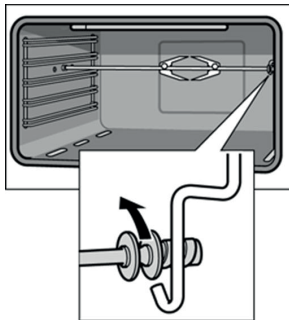

2. Carefully withdraw the rotary spit from the recessed adapter in the side panel and remove it from the oven.
3. Take out the baking tray.

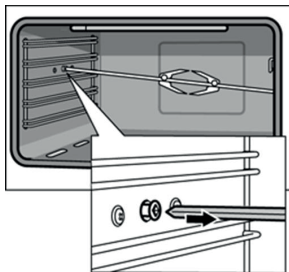

Cleaning and Care

Never use high-pressure cleaners or steam jets. Risk of short circuit.

Never use caustic or abrasive cleaning agents. These could damage the surface. If such an agent gets on the front of the appliance, wipe it off immediately with water.

Do not clean any surfaces of the appliance while they are hot.

Switching on the oven lighting

To make it easier to clean the oven, you can switch on the oven lighting.
To switch on the lighting, press the function button for oven lighting until it locks into place.

Catalytic cooking compartment panels

The catalytic cooking compartment panels are coated with self-cleaning enamel.

The surfaces clean themselves while the oven is in operation. Larger splashes will only be removed after the oven has been used several times.

Self-cleaning surfaces

The rear and side walls are protected with catalytic panelling.
Never clean these surfaces with oven cleaner.

Slight discolouration of the enamel does not affect automatic self-cleaning.

Cleaning and Care (Continued)

Using the correct cleaning agent

Do not use cleaning agents that contain abrasive substances or acids, or cleaning aids such as steel wool or stainless steel sponges. These could damage the surfaces.

Appliance parts	Cleaning agent and cleaning aid
Appliance door glass panel	<ul style="list-style-type: none"> • Use glass cleaner. Risk of injury. The lower edge of the door may have sharp edges. Clean the door and glass panels with care. • Do not use a glass scraper.
Control panel and knobs	<ul style="list-style-type: none"> • Wipe with a damp, soft cloth.
Seal (on the cooking compartment)	<ul style="list-style-type: none"> • Use warm soapy water.
Hook-in racks	<ul style="list-style-type: none"> • Use warm soapy water.
Cooking compartment Enamelled surfaces	<ul style="list-style-type: none"> • Use warm soapy water; Dry off with a soft cloth.
Appliance exterior Stainless steel surfaces	<ul style="list-style-type: none"> • Use warm soapy water; Dry off with a soft cloth. • Always remove flecks of limescale, grease, starch and albumin (e.g. egg white) immediately. • Special stainless steel cleaners are available from the after-sales service or specialist shops.
Glass cover (in front of the oven lighting)	<ul style="list-style-type: none"> • Use warm soapy water.
Pan support	<ul style="list-style-type: none"> • Use warm soapy water. • Do not clean the pan supports in the dishwasher.
Appliance parts	Cleaning agent and cleaning aid
Accessory	<ul style="list-style-type: none"> • Soak in hot soapy water. Clean with a brush or sponge.

Cleaning and Care (Continued)

Cleaning the interior glass of the oven

The interior glass of the oven door can be removed: with the door in the semi-open position, use both hands to remove the glass. After cleaning, refit the the glass by proseeding in reverse order.

Note

In some models, the glass is screenprinted. In this case, when refitting the glass make sure the screenprinted part is legible when the oven door is opened.

The interior glass of the oven

The interior glass of the oven door can be removed: with the door in a semi-open position, remove the screws **A** and **B** and the profile **C** as shown in fig. 9

Use both hands to remove the glass as shown in figures 9A. After cleaning, refit the glass by proceeding in reverse order.

Fig 9

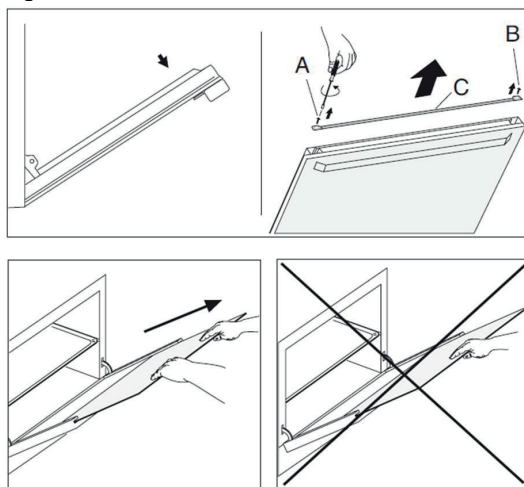
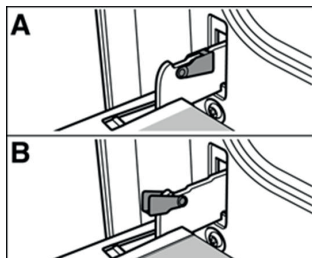

Fig 9A

Cleaning and Care (Continued)

Removing and fitting the appliance door

You can remove the appliance door for easier cleaning.



The hinges of the appliance door are each secured by a locking lever. When the locking lever is folded in (A), the appliance door is secured. It cannot be unhinged. If the locking lever is open (B), only the hinge is secured, and you can remove the appliance door.

Risk of injury.

Do not reach inside the hinge.

Removing the appliance door



Proceed as follows:

1. Open the appliance door.
2. Lift up the locking levers on both sides.

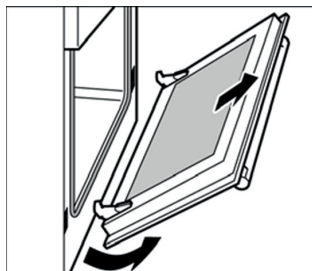

3. Close the appliance door until you feel resistance at an angle of around 15° (in relation to the closed appliance door).
4. Grip the door on either side with both hands.
5. Close the appliance door a little further.
6. Lift the door upwards and at an angle to remove it.

Do not disassemble the door.

Cleaning and Care (Continued)

Fitting the appliance door

Proceed as follows:

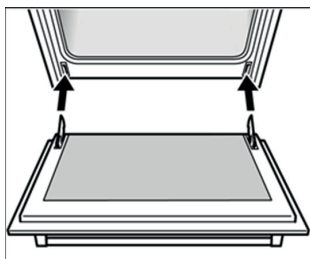

1. Hold the appliance door at an angle.
2. Insert both hinges, left and right, into the supports.

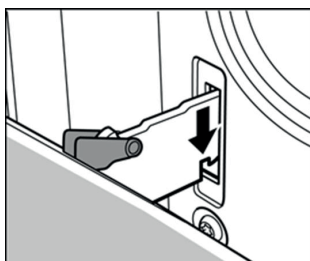

3. Position the door so that the hinge grooves engage on both sides.
4. Open the appliance door.



5. Fold in the locking levers on both sides.
6. Close the appliance door.

Cleaning and Care (Continued)

Removing and inserting the hook-in racks

You can remove the hook-in racks in order to clean them separately.

The hook-in racks are all fixed to the walls of the cooking compartment at four points.

To remove the hook-in racks, proceed as follows:

Removing the hook-in racks

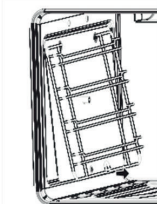

1. Undo the screw on the bottom the hookin rack.
The lower hooks of the hook in rack are released.

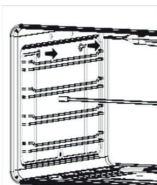

2. Take hold of the top of the hook-in rack and screw on the screw on the bottom the hook-in rack again.

Inserting the hook-in rack

To reinsert the hook-in racks, proceed as follows:



1. Insert the upper hooks into the drill holes in the side panel.



2. Pull the hook-in rack slightly downwards and insert the lower hooks into the drill holes.

Troubleshooting

Malfunctions often have simple explanations. Please read the following notes before calling the aftersales service.

Fault	Possible cause	Remedial action
The door panel steams up when the oven is hot.	Normal occurrence; caused by the difference in temperature.	Not possible; this has no effect on oven performance.
The appliance does not work.	Defective circuit breaker	Look in the fuse box and check that the circuit breaker for the appliance is in working order.
	Power cut	Check whether the kitchen light works, for example.
All dishes that are prepared in the oven become burnt very quickly.	Thermostat faulty	Call the after-sales service.
The oven lighting has failed.	Oven light is faulty	Replace the oven light. (see section "Replacing oven light")

Repairs may only be carried out by fully trained after-sales service engineers.

If your appliance is not repaired professionally, you may be exposing yourself to substantial risks.

Troubleshooting (Continued)

Replacing the oven light bulb

WARNING: Ensure that the appliance is switched off before replacing the lamp to avoid the possibility of electric shock

If the oven light bulb fails, it must be replaced. Replacement heat-resistant bulbs can be obtained from the after-sales service or from specialist retailers. Please specify the SN number of your appliance. Do not use any other type of bulb.

Proceed as follows:

1. Switch off the relevant circuit breaker.
2. Open the appliance door.
3. Lay a tea towel in the cooking compartment if it is cold to prevent damage.
4. Unscrew the glass cover from the bulb inside the cooking compartment by turning it anti-clockwise.
5. Replace the bulb with one of the same type.

Voltage: 230 V

Power: 25 W

Thread: E14

Temperature resistance: 300°C

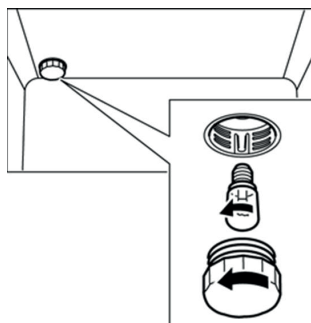

6. Screw on the glass cover again.
7. Remove the tea towel and switch the circuit breaker back on.

Turn the oven switch or your control panel in

position  in order to check whether the oven lighting is working properly.



Troubleshooting (Continued)

Aftersales service

Our after-sales service is there for you if your appliance needs to be repaired. You will find the address and telephone number of your nearest after-sales service centre in the phone book. The after-sales service centres listed will also be happy to give you the details of an after-sales service point near you.

SN number

Please quote the SN number of the appliance when contacting the after-sales service. These numbers can be found on the rear backboard.

So you do not have to spend time looking for it if there is a fault, you can enter the data for your appliance here now.

SN no.

After-sales service

Tips and Tricks

The following are tips and tricks to help you when cooking food in your appliance.

Tips for saving energy

Here are a few tips for saving energy when using the hob and oven.

Tips on using the hob

Suitable cookware diameter

Make sure that the diameter of the cookware is suitable for the diameter of whichever hotplate you are using. You can find an overview of suitable diameters in the section entitled "Your new appliance - the hob". The flame of the gas burner must not be larger than the diameter of the cookware.

Cookware with lids

Use cookware with a flat bottom. If possible, use cookware with lids to save gas.

Less water

To reduce the cooking time for e.g. vegetables and potatoes, use less water.

Tips on using the oven

Several cakes

It is best to bake several cakes one after the other. The oven is still warm. This reduces the baking time for the second cake. You can also place two cake tins next to each other.

Using residual heat

Where longer cooking times are used, you can switch the oven off 10 minutes before the end of the cooking time and use the residual heat to finish cooking.

Closing the appliance door

Always keep the appliance door closed when it is in operation. If you need to open the appliance door, close it again as soon as possible. Otherwise, the temperature will drop and the oven will need to heat itself up again.



Tips and Tricks (Continued)

Tips for using your appliance

The following tips relate to ovenware and cooking and explain what to do if something goes wrong.

General tips

Since a lower temperature allows more even browning.

Clean the appliance and accessories after each use, once they have cooled down.

Always place baking tins or ovenware in the centre of the wire rack.

Always place cookware in the middle of the hotplate on the hob.

Boiling and frying

Cookware

For dishes which require a lot of liquid, use deep-sided pots so that they do not boil over.

The pan base must be clean, dry and flat.

Tips and Tricks (Continued)

Baking tips

How to confirm whether your sponge cake is cooked through.	Approximately 10 minutes before the end of the baking time stated in the recipe, pierce the highest point of the cake with a wooden skewer. If no cake mixture sticks to the wood, the cake is ready.
The cake collapses.	Next time, use less liquid or bake at a slightly lower temperature. Note the stirring times indicated in the recipe.
The cake has risen high in the middle and less around the edges.	Do not grease the edges of the baking tin. After baking, carefully loosen the cake using a knife.
The cake is too dark on the top.	Place the cake lower in the oven and bake at a lower temperature for slightly longer.
The cake is too dry.	Make tiny holes in the finished cake using a cocktail stick. Then pour fruit juice or an alcoholic drink over the cake. Next time, bake at a slightly higher temperature for less time.
The bread or cake looks good but it is streaked with water inside.	Next time, use less liquid and bake at a lower temperature for slightly longer. For cakes with a moist topping: Pre-bake the base first. Sprinkle the base with almonds and breadcrumbs and then pour the topping on. Take care to follow recipes and baking times.
The pastries are not evenly browned.	Set the temperature slightly lower. Excess greaseproof paper can affect the air circulation. Always cut the greaseproof paper down to the size of the baking tray.

Tips on using the rotary spit

Place the joint as centrally as possible on the rotary spit and secure it at both ends with the retaining clips.

You can also truss the joint with string. With poultry, bind the ends of the wings underneath the back and the thighs against the body. This will prevent them from becoming too dark. Pierce the skin on the underside of the wings to allow the fat to escape.



Wiring Diagram

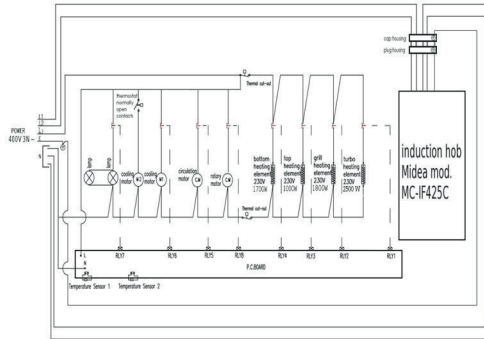

Wiring diagram multifunction oven. 1 fan with hot air
Induction Cooktop

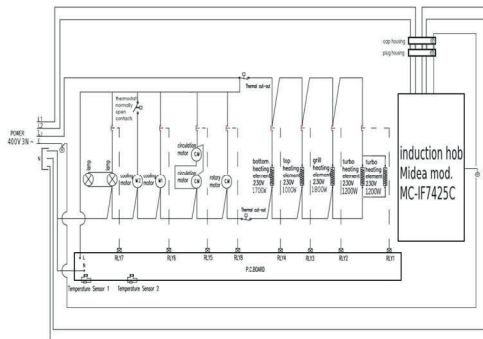

Wiring diagram multifunction oven with 2 heaters
Induction Cooktop

Warranty

Warranty terms and conditions: Cooking appliances (cookers)

This document sets out the terms and conditions of the product warranties for Residentia Group Appliances. It is an important document. Please keep it with your proof of purchase documents in a safe place for future reference should you require service for your Appliance.

1. In this warranty
 - (a) 'acceptable quality' as referred to in clause 10 of this warranty has the same meaning referred to in the ACL;
 - (b) 'ACL' means Trade Practices Amendment (Australian Consumer Law) Act (No.2) 2010;
 - (c) 'Appliance' means any Residentia Group product purchased by you accompanied by this document;
 - (d) 'ASR' means Residentia Group authorised service representative;
 - (e) 'Residentia Group' means Residentia Group Pty Ltd of 20 Yaltara Avenue, Bundoora Victoria 3083, ACN 600 546 656 in respect of Appliances purchased in Australia;
 - (f) 'major failure' as referred to in clause 10 of this warranty has the same meaning referred to in the ACL and includes a situation when an Appliance cannot be repaired or it is uneconomic for Residentia Group, at its discretion, to repair an Appliance during the Warranty Period;
 - (g) 'Warranty Period' means:
 - (i) where the Appliance is used for personal, domestic or household use (i.e. normal single family use) as set out in the instruction manual, the Appliance is warranted against manufacturing defects for 24 months, following the date of original purchase of the Appliance;
 - (h) 'you' means the purchaser of the Appliance not having purchased the Appliance for re-sale, and 'your' has a corresponding meaning.
2. This warranty only applies to Appliances purchased and used in Australia and is in addition to (and does not exclude, restrict, or modify in any way) any non-excludable statutory warranties in Australia.
3. During the Warranty Period Residentia Group or its ASR will, at no extra charge if your Appliance is readily accessible for service, without special equipment and subject to these terms and conditions, repair or replace any parts which it considers to be defective. Residentia Group or its ASR may use remanufactured parts to repair your Appliance. You agree that any replaced Appliances or parts become the property of Residentia Group. This warranty does not apply to light globes, batteries, filters or similar perishable parts.
4. Parts and Appliances not supplied by Residentia Group are not covered by this warranty.



Warranty (Continued)

5. You will bear the cost of transportation, travel and delivery of the Appliance to and from Residentia Group or its ASR. If you reside outside of the service area, you will bear the cost of:
 - (a) travel of an authorised representative;
 - (b) transportation and delivery of the Appliance to and from Residentia Group or its ASR, in all instances, unless the Appliance is transported by Residentia Group or its ASR, the Appliance is transported at the owner's cost and risk while in transit to and from Residentia Group or its ASR.
6. Proof of purchase is required before you can make a claim under this warranty.
7. You may not make a claim under this warranty unless the defect claimed is due to faulty or defective parts or workmanship. Residentia Group is not liable in the following situations (which are not exhaustive):
 - (a) the Appliance is damaged by:
 - (i) accident
 - (ii) misuse or abuse, including failure to properly maintain or service
 - (iii) normal wear and tear
 - (iv) power surges, electrical storm damage or incorrect power supply
 - (v) incomplete or improper installation
 - (vi) incorrect, improper or inappropriate operation
 - (vii) insect or vermin infestation
 - (viii) failure to comply with any additional instructions supplied with the Appliance;
 - (b) the Appliance is modified without authority from Residentia Group in writing;
 - (c) the Appliance's serial number or warranty seal has been removed or defaced;
 - (d) the Appliance was serviced or repaired by anyone other than Residentia Group, an authorised repairer or ASR.
8. This warranty, the contract to which it relates and the relationship between you and Residentia Group are governed by the law applicable where the Appliance was purchased.
9. To the extent permitted by law, Residentia Group excludes all warranties and liabilities (other than as contained in this document) including liability for any loss or damage whether direct or indirect arising from your purchase, use or non use of the Appliance.
10. For Appliances and services provided by Residentia Group in Australia, the Appliances come with a guarantee by Residentia Group that cannot be excluded under the Australian Consumer Law. You are entitled to a replacement or refund for a major failure and for compensation for any other reasonably foreseeable loss or damage. You are also entitled to have the Appliance repaired or replaced if the Appliance fails to be of acceptable quality and the failure does not amount to a major failure. The benefits to you given by this warranty are in addition to your other rights and remedies under a law in relation to the Appliances or services to which the warranty relates.
11. At all times during the Warranty Period, Residentia Group shall, at its discretion, determine whether repair, replacement or refund will apply if an Appliance has a valid warranty claim applicable to it.
12. To enquire about claiming under this warranty, please follow these steps:
 - (a) carefully check the operating instructions, user manual and the terms of this warranty;
 - (b) have the model and serial number of the Appliance available;
 - (c) have the proof of purchase (e.g. an invoice) available;
 - (d) telephone the numbers shown below.
13. You accept that if you make a warranty claim, Residentia Group and its ASR may exchange information in relation to you to enable Residentia Group to meet its obligations under this warranty.

IMPORTANT

Before calling for service, please ensure that the steps in point 12 have been followed.

Telephone contacts

- ▶ Service: Please call 1300 11 HELP (4357)
- ▶ Spare Parts: Please call 1300 11 SPARE (7727)

The Australian Consumer Law requires the inclusion of the following statement with this warranty:

Our goods come with guarantees that cannot be excluded under the Australian Consumer Law. You are entitled to a replacement or refund for a major failure and for compensation for any other reasonably foreseeable loss or damage. You are also entitled to have the goods repaired or replaced if the goods fail to be of acceptable quality and the failure does not amount to a major failure.

DESIGNED IN MELBOURNE

INALTO

FOR ALL AUSTRALIAN HOMES

WWW.INALTO.HOUSE



E2447

PN :16171100A40069