

USER MANUAL

INALTO?

INALTO.HOUSE

60cm 13 Function Compact Combi Microwave Oven

MODEL CODE/S
IOMC6013T



FOR ALL AUSTRALIAN HOMES

V 1.3 | 0423

Welcome

Congratulations on purchasing your new InAlto Compact Combi Microwave Oven!

Residentia Group Pty Ltd

ACN. 600 546 656

165 Barkly Avenue

Burnley, Victoria 3121

Australia

—

Applico Ltd

635 Great South Road

Penrose, Auckland 1061

New Zealand

—

InAlto

www.inalto.house

 /inalto.house

 /inalto.house

The InAlto brand is proudly distributed within Australia by Residentia Group Pty Ltd and within New Zealand by Applico Ltd.

Please refer to the warranty card at the rear of this manual for information regarding your product's parts and labour warranty, or visit online at:

→ www.residentia.group

→ www.applico.co.nz

→ www.inalto.house

Both Residentia Group & Applico are customer obsessed and our Support Teams are there to ensure you get the most out of your appliance. Should you want to learn more about recommended usage, the various features of your appliance, and importantly taking care of the unit when cleaning, our Support Teams are here to help.

Telephone Contacts:

→ AU: 1300 11 4357

→ NZ: 0800 763 448

It is important that you read through the following use and care manual thoroughly to familiarise yourself with the installation and operation requirements of your appliance to ensure optimum performance.

Again, thank you for choosing an InAlto appliance and we look forward to being of service to you.

SCAN ME

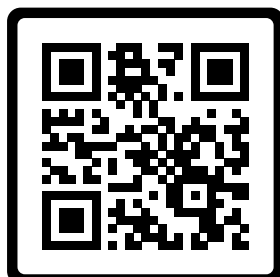

Scan to Register your InAlto Appliance or go to:

→ AU: www.inalto.house/registration

→ NZ: www.inalto.house/nz/registration

By registering your product, you will receive advanced support, stay updated with the latest from InAlto and find out about new products and promotions.

Contents

- [2 Welcome](#)
- [4 Safety Instructions](#)
- [8 Your InAlto Combi Oven](#)
- [11 Before First Use](#)
- [12 Operation Instructions](#)
- [18 Installation Instructions](#)
- [22 Cleaning & Maintenance](#)
- [23 Troubleshooting](#)
- [24 Energy Saving](#)
- [25 Technical Specifications](#)
- [26 Purchase Details](#)
- [27 Your Receipt](#)
- [28 Warranty Information](#)

Customer Care

InAlto recommends the use of original spare parts. When contacting our customer service team on 1300 11 4357, please ensure that you have the following information at hand (which can be found on your appliances' rating plate).

- Model Number
- Serial Number

Safety Instructions

IMPORTANT INFORMATION

The following statements you will see in this booklet have these meanings:

WARNING!

Indicating information concerning your personal safety.

CAUTION

Indicating information on how to avoid damaging the appliance or cabinetry.

IMPORTANT

Indicating tips and information about use of the appliance.

CONDITIONS OF USE

This appliance is intended to be used in domestic environments (i.e. households) and similar applications such as:

- Staff kitchen areas in shops, offices and other working environments
- By clients in hotels, motels and other residential type environments
- Farm houses
- Bed and breakfast type environments
- Catering and similar non-retail applications

BEFORE USING YOUR APPLIANCE

Before you use the appliance, we recommend that you read through the relevant sections of this manual, which provides the description of your appliance and its functions.

To avoid the risks that are always present when you use an appliance, it is important that the appliance is installed correctly and that you read the safety instructions carefully to avoid misuse and hazards.

We recommend that you keep this instruction booklet for future reference and pass it on to any future owners.

IMPORTANT SAFETY INSTRUCTIONS

To reduce the risk of fire, electric shock, injury to persons or exposure to excessive microwave oven energy when using your appliance, follow basic precautions, including the following:

1. This appliance can be used by children aged from 8 years and above and persons with reduced physical, sensory or mental capabilities or lack of experience and knowledge if they have been given supervision or instruction concerning use of the appliance in a safe way and understand the hazards involved. Children shall not play with the appliance. Cleaning and maintenance of the appliance must not be done by children without supervision.
2. Read and follow the following, Precautions to avoid possible exposure to excessive microwave energy.
 - (a) Do not attempt to operate this oven with the door open since this can result in harmful exposure to microwave energy. It is important not to break or tamper with the safety interlocks.
 - (b) Do not place any object between the oven front face and the door or allow soil or cleaner residue to accumulate on sealing surfaces.
 - (c) **WARNING** If the door or door seals are damaged, the oven must not be operated until it has been repaired by a competent person.
3. Keep the appliance cord out of reach from children less than 8 years,
4. If the supply cord is damaged, it must be replaced by the manufacturer, its service agent or similarly qualified persons in order to avoid a hazard. (For appliance with type Y attachment)
5. **WARNING** It is hazardous for anyone other than a qualified technician to carry out any service or repair operation that involves the removal of the cover which gives protection against exposure to microwave energy.
6. **WARNING** Liquids and other foods must not be heated in a sealed container as they will then be liable to explode during cooking.
7. This appliance is not intended for use by persons (including children) with reduced physical, sensory or mental capabilities, or lack of experience and knowledge, unless they have been given supervision or instruction concerning use of the appliance by a person responsible for their safety. Children shall not play with the appliance.
8. When heating food in plastic or paper containers, keep an eye on the oven due to the possibility of ignition.

-
9. Only use utensils that are suitable for use in microwave ovens.
 10. If smoke is emitted, switch off or unplug the appliance and keep the door closed in order to stifle any flames.
 11. Microwave heating of beverages can result in delayed eruptive boiling, therefore care must be taken when handling the container.
 12. The contents of deeding bottles or baby food jars should be stirred or shaken and the temperature checked before consumption in order to avoid burns.
 13. Eggs in their shell and whole hard-boiled eggs should not be heated in microwave ovens since they may explode, even after microwave heating has ended.
 14. The oven should be cleaned regularly and any food debris removed.
 15. Failure to maintain the oven in a clean condition could lead to deterioration of the surface that could adversely effect the life of the appliance and possible result in a hazardous situation.
 16. This appliance must only be used in household or similar applications as outlines in the conditions of use.
 17. This appliance shall not be cleaned with a steam cleaner.
 18. **WARNING** Ensure the appliance is switched off before replacing the lamp to avoid the possibility of electric shock.
 19. **WARNING** Accessible parts may become hot during use. Young children should be kept away.
 20. The microwave oven is intended for heating food and beverages only. Drying of food or clothing and heating or warming of pads, slippers, sponges, cloths or any similar items may lead to risk of injury, ignition or fire.
 21. Surface of the appliance and door can get hot.
 22. **WARNING** The appliance and its accessible parts become hot during use. Care should be taken to avoid touching heating elements. Children under the age of 8 should be kept away at all times unless they are being continuously supervised.
 23. During use the appliance becomes hot. Care should be taken to avoid touching heating elements inside the oven.
 24. Metallic containers for food and beverages are not allowed during microwave cooking.
 25. Do not use hard or abrasive cleaners or sharp metal scrapers to clean the oven door glass as they may scratch the surface of the glass which could lead to damage or shattering of the glass.
 26. The appliance is intended to be used built-in only. .
 27. The appliance must not be installed behind any cabinetry or decorative door panel in order to avoid overheating.
 28. **WARNING** When the appliance is operated in the combination mode, children should only use the oven under supervision of an adult as there are great temperatures generated.

Safety Instructions (Continued)

CAUTION! CAUSES OF DAMAGE

- Creation of sparks: Metal e.g. a spoon in a glass must be kept at least 2 cm from the oven walls and the inside of the door. Sparks could irreparably damage the glass on the inside of the door.
- Water in the hot cooking compartment: Never pour water into the hot cooking compartment. This will cause steam. The temperature change can cause damage.
- Moist food: Do not store moist food in the closed cooking compartment for long periods. Do not use the appliance to store food. This can lead to corrosion.
- Cooling with the appliance door open: Only leave the cooking compartment to cool with the door closed. Do not trap anything in the appliance door. Even if the door is only slightly ajar, the fronts of adjacent units may be damaged over time.
- Heavily soiled seal: If the seal is very dirty, the appliance door will no longer close properly during operation. The fronts of adjacent units could be damaged. Always keep the seal clean.
- Operating the microwave without food: Operating the appliance without food in the cooking compartment may lead to overloading. Never switch on the appliance unless there is food in the cooking compartment.
- Using the appliance door for standing on or placing objects on: Do not stand or place anything on the open appliance door. Do not place oven ware or accessories on the appliance door.
- Transporting the appliance: Do not carry or hold the appliance by the door handle. The door handle cannot support the weight of the appliance and could break.
- Microwave popcorn: Never set the microwave power too high. Use a power setting no higher than 600 watts. Always place the popcorn bag on a glass plate. The disc may jump if overloaded.
- Liquid that has boiled over must not be allowed to run through the turntable drive into the interior of the appliance. Monitor the cooking process. Choose a shorter cooking time initially, and increase the cooking time as required.
- The oven should be cleaned regularly and any food deposits removed since they may explode, even after microwave heating has ended.
- Failure to maintain the oven in a clean condition could lead to deterioration of the surface that could adversely affect the life of the appliance and possibly result in a hazardous situation.

PLEASE READ ALL POINTS VERY CAREFULLY AND RETAIN THIS MANUAL FOR FUTURE REFERENCE.

IMPORTANT Check for any damage or marks. If you find the appliance is damaged or marked, you must report it within 7 days if you wish to claim for damage/marks under the manufacturer's warranty. This does not affect your statutory rights. A damaged appliance should never be installed.

THIS PAGE IS INTENTIONALLY LEFT BLANK

Your InAlto Combi Oven

TOUCH KEYS AND DISPLAY

The touch keys are used to set the various functions of the appliance.
You can view on the display screen what functions you have set.

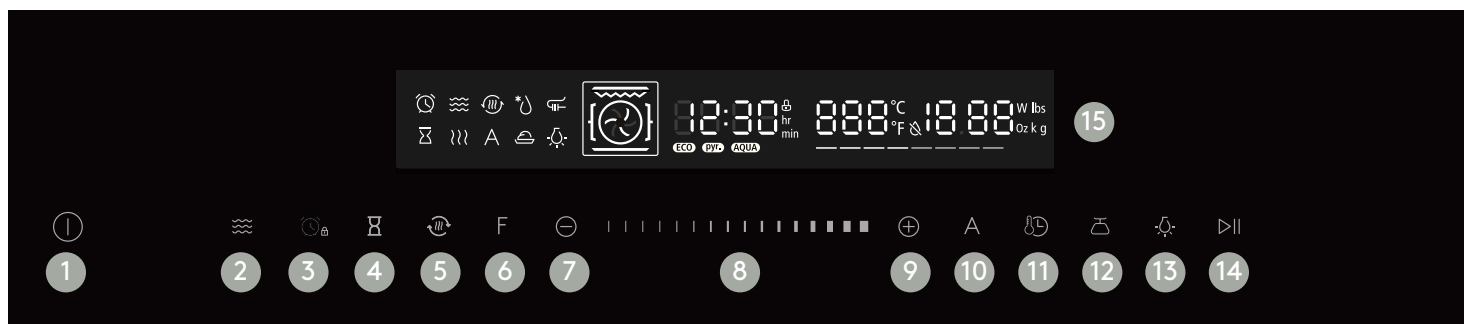

1. On/Off
2. Microwave
3. Timer/Child lock
4. Preset
5. Preheat
6. Function
7. Decrease parameter adjustment
8. Slider parameter adjustment
9. Increase parameter adjustment
10. Auto menu
11. Clock/Temperature
12. Weight
13. Light
14. Start/Pause
15. Display screen

Please note, the image above is indicative only. Your appliance may appear differently.

PARAMETER ADJUSTMENT

Use the adjusting keys to set the parameters.

Auto menu	Select 13 automatic programmes. From P 01 to P 13.
Temperature	Select the temperature of cooking(°C). : 100-235 : 50-250 : 50-250 : 50-235 : 50-235 + : 50-250 : 100-235 + : 50-250 : 100-250 + : 50-250 : 100-235
Weight	Set the weight of cooking.
Time	Set the time of cooking.
Microwave	Select microwave power.100W,300W 500W,700W and 900W

FUNCTION AND SCREEN DISPLAY

Use the function key to set the type of cooking. The following symbols will display on the screen to indicate which type you have selected.

Conventional	The top and bottom elements work together to provide conventional cooking. The oven needs to be pre-heated to the required temperature: ideal for slow cooking dishes such as casseroles and stews.
Convection	For baking on several levels(e.g. baking trays of chocolate chip cookies).
Conventional + Fan	Convenient and time savings, up to 4 dishes can be cooked simultaneously on different shelves without mixing of taste or smell.
Radiant Grilling	Best results can be obtained from using the top shelf for small items and lower shelves for larger items.
Double Grill+Fan	For gratin dishes and finishing roasted vegetables.
Double Grilling	The inside radiant elements and outside top element work simultaneously giving a rapid and even grilling heat, therefore effectively browning the top surface of the food.
Pizza	Pizza is perfectly cooked with extra heat from both bottom and sides of the oven, guaranteeing pizza bases are crispy.
Lower Heater Element	This is ideal for slow cooking dishes such as casseroles, stews.
Microwave	Defrost,reheat and cooking.
+ MW+Convection	For reducing large portions' cooking time with browning finish.
+ MW+ Double Grill +Fan	This function is suitable where quick browning is required; will cook the ingredients down to the core.
+ MW+Pizza	This function is suitable where quick under browning is required; will cook the ingredients down to the core.
* Defrost	3 defrosting programmes
A Auto-programs	13 cooking programmes The type of heating and cooking time are set by weight .

Your InAlto Combi Oven (Continued)

COOLING FAN

Your appliance has a cooling fan. The cooling fan switches on during operation. The hot air escapes above the door. The cooling fan continues to run for a period of time after operation.

CAUTION! Do not cover the ventilation slots, otherwise the appliance will overheat.

Notes

The appliance remains cool during microwave operation. The cooling fan will still switch on. The fan may run on even when microwave operation has ended.

Condensation may appear on the door window, interior walls and floor. This is normal and does not adversely affect microwave operation. Wipe away the condensation after cooking.

ACCESSORIES

Grill Rack

Used for grilling a range of foods eg. meat or toasting bread.

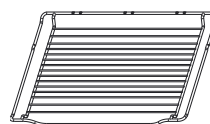

Enamel Baking Tray

Suitable for a range of oven functions. Do not use during microwave operation.

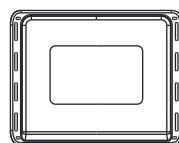

Glass Baking Tray

Suitable to use during the microwave function.

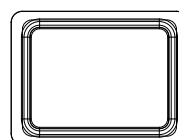

Note: The baking trays should be placed in the bottom side hanger and not directly on the base of the unit. Refer to the illustrations below.

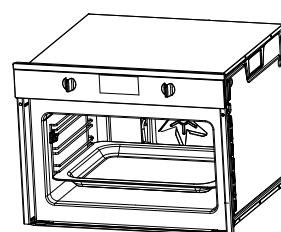
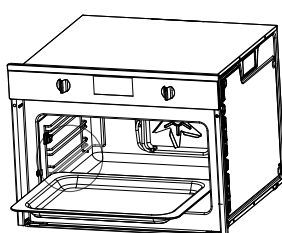
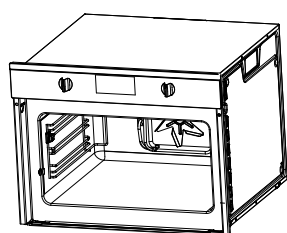



Before First Use

BEFORE USING THE APPLIANCE FOR THE FIRST TIME

- Before using this appliance read this manual, taking special note of the 'Safety Instructions' section.
- Ensure that all packaging materials are removed from the appliance.

SETTING THE OVEN CLOCK



1. In waiting state, touch the  button to enter the clock setting mode. "00:00" will display and the hour figures will flash.
2. Touch the - /+ or slide the slider bar to set the hour figures. The input time should be within 0-23.
3. Touch the  to confirm, then the minute figure will flash.
4. Touch the - /+ or slide the slider bar to set the minute figures. The input time should be within 0-59.
5. Touch  to finish clock setting, ":" will flash. The time is now set and the appliance will enter waiting state.

CLEANING THE ACCESSORIES

Before you use the accessories for the first time, clean them thoroughly with hot soapy water and a soft dish cloth.

HEATING UP THE OVEN

To remove the new cooker smell, heat up the oven when it is empty and closed. One hour with convection at 250°C is ideal. Ensure that no packaging remnants have been left in the cooking compartment.

1. In waiting state, touch the F button once. The default temperature and conventional symbol will show on the display.
2. Touch the F button repeatedly until the convection symbol displays. The default temperature of convection will display.
3. Touch the - /+ or slide the slider bar to set the temperature to 250°C.
4. Touch  to enter cooking time setting mode. "00:00" will flash.
5. Touch - /+ or slide the slider bar to set the cooking time to 60 minutes.
6. Touch the  button. The oven begins to heat up.



Operation Instructions

SETTING THE OVEN

There are various ways in which you can set your oven. Here we will explain how you can select the desired type of heating and temperature or grill setting. You can also select the oven cooking time for your dish. Please refer to the section on Setting the time setting options .

Setting the type of heating and temperature

Example: Radiant Grilling at 200°C for 25 minutes.

1. In waiting state, touch the F button once. The default temperature and conventional symbol will show on the display.
2. Touch the F button repeatedly until your desired mode displays in this case radiant grilling. The default temperature for radiant grilling will display.
3. Touch the - / + or slide the slider bar to set the temperature to your desired temperature in this case 200°C.
4. Touch  to enter cooking time setting mode. "00:00" will flash.
5. Touch - / + or slide the slider bar to set the cooking time to your desired time in this case 25 minutes.
6. Touch the  button. The oven begins to heat up.

Opening the oven door during operation

Operation is suspended. After closing the door, touch the  button to continue operation.

Pausing operation

Touch the  button to pause operation. Then touch it again to restart operation.

Changing the cooking time

This can be done at any time during cooking. Touch the  button repeatedly until the cooking time flashes and then use the - / + or the slider control to adjust the time set.

Changing the temperature









This can be done at any time during cooking. Touch - / + buttons or use the slider control to adjust the temperature.

Canceling operation

This can be done at any time. Simply press the  button and the unit will enter the waiting state.

RAPID PREHEATING

With rapid preheating, your oven reaches the set temperature very quickly. It is available for the following oven functions.

 Conventional	 Double Grill+Fan
 Convection	 Double Grilling
 Conventional + Fan	 Pizza
 Radiant Grilling	 Lower Heater Element

To ensure an even cooking result, only put your food in the cooking compartment when the preheating phase is complete.

To use this function set your type of heating and temperature required and then press the  button.

The symbol will light up on the display and the oven will begin to heat up.

When the preheating process is complete a signal will sound and the preheating symbol will blink on the display screen. Place your dish in the oven.

Canceling rapid preheating

This can be done at any time by pressing the  button.

Note: Keep the oven door closed during this function until you hear the alarm and the preheating symbol is blinking on the display screen. Once you hear the alarm you can then put food in the oven.

THE MICROWAVE

Microwaves are used to heat various food items. The microwave can be used on its own, or in combination with a different types of heating.

Note:

The step quantities for the adjustment of times in each of the various time brackets are as follows;

0-1 minute	5 seconds
1-3 minutes	10 seconds
3-15 minutes	30 seconds
15-60 minutes	1 minute
Over 60 minutes	5 minutes

NOTES REGARDING OVENWARE

Suitable ovenware

Suitable dishes are heat-resistant ovenware made of glass, ceramic glass, porcelain, ceramic or heat-resistant plastic. These materials allow microwaves to pass through.

You can also use serving dishes. This saves you having to transfer food from one dish to another. You should only use ovenware with decorative gold or silver trim if the manufacturer guarantees that they are suitable for use in microwaves.

Unsuitable ovenware

Metal ovenware is unsuitable. Metal does not allow microwaves to pass through. Food in covered metal containers will remain cold.

CAUTION!

Creation of sparks: metal – e.g. a spoon in a glass – must be kept at least 2 cm from the oven walls and the inside of the door.

Sparks could destroy the glass on the inside of the door.

Ovenware test

Do not switch on the microwave unless there is food inside. The following ovenware test is the only exception to this rule.

Perform the following test if you are unsure whether your ovenware is suitable for use in the microwave:

1. Heat the empty ovenware at maximum power for ½ to 1 minute.
2. Check the temperature occasionally during that time. The ovenware should still be cold or warm to the touch. The ovenware is unsuitable if it becomes hot or sparks are generated.

MICROWAVE POWER SETTINGS

Use the microwave button  to set the desired microwave power.



100W	-Defrosting sensitive/delicate foods -Defrosting irregularly-shaped foods -Softening ice cream -Allowing dough to rise
300 W	-Defrosting -Melting chocolate and butter
500 W	-cooking rise , soup
700 W	-Reheating -cooking mushrooms, shell fish -cooking dishes containing eggs and cheese
900 W	-Boiling water, reheating -cooking chicken, fish, vegetables

Notes

- When you touch a key, the selected power lights up.
- The microwave power can be set to 900 watts for a maximum of 30 minutes. With all other power settings a maximum cooking time of 1 hour 30 minutes is possible.

SETTING THE MICROWAVE

Example: Microwave power setting 300 W, cooking time 17 minutes.

1. In waiting state, touch the  button to enter microwave operation. The default microwave power 900W will appear and the default cooking time will flash.
2. Touch the - / + or slide the slider bar to set the cooking time to 17 minutes.
3. Touch  button to activate the microwave power. Then touch - / + or slide the slider bar to set the microwave power to 300W
4. Touch the  button.
Operation begins and the time starts counting down on the display.

The cooking time has elapsed

A signal sounds. Microwave operation has finished.

Opening the oven door during operation

Operation will automatically suspend. After closing the door press the  button and operation will continue.

Changing the cooking time

This can be done at any time by touching - / + or by sliding the slider control.

Operation Instructions (Continued)

Changing the microwave power setting

This can be done at any time. Touch the  button and then touch -/+ or the slider control to adjust the microwave power setting.

Pausing operation

Touch the  button to pause operation. Then touch it again to restart operation.

Canceling operation

This can be done at any time.

Simply press the  button and the unit will enter the waiting state.

Notes

- If you open the appliance door during cooking, the fan may continue to run.





MICROWAVE COMBI OPERATION

This involves simultaneous operation of the grill and the microwave. Using the microwave makes your dishes heat up quickly, and combining this with the grill ensures they are still nicely browned.

You can use this on all microwave power settings with the exception of 700 and 900 watts.

Setting Microwave Combi Operation

Example: Microwave + Pizza function with 500W and 190°C for 17 minutes.

1. In waiting state, touch the  button and then touch the F button repeatedly to set Micro Combi mode. Stop pressing this button until the display shows your desired setting, in this case the Pizza icon and Microwave icon.
2. Touch the -/+ or slide the slider bar to set the temperature to 190°C
3. Touch  button to confirm the temperature. The default cooking time will then flash, and then touch the -/+ or slider to set the cooking time to 17 minutes.
4. Touch the  button. The default power will blink. Touch the -/+ or slider control to adjust the microwave power to 500W.
5. Touch the  button. The appliance will begin operation and the timer will start counting down.

The cooking time has elapsed

A signal sounds. Combination mode has finished.

Opening the oven door during cooking

Operation will be suspended. After closing the door, touch the  button and the program will then continue.

Pausing operation

Touch the  button to pause operation. Then touch it again to restart operation.

Changing the cooking time

This can be done at any time during cooking. Touch the  button repeatedly until the cooking time flashes and then use the -/+ or the slider control to adjust the time set.

Changing the microwave power setting

This can be done at any time. Touch the  button and then touch -/+ or the slider control to adjust the microwave power setting.

Changing the temperature

This can be done at any time during cooking.

Touch -/+ buttons or use the slider control to adjust the temperature.

Canceling operation



This can be done at any time.

Simply press the  button and the unit will enter the waiting state.

AUTOMATIC PROGRAMS

The automatic programs enable you to prepare food very easily. You select the program and enter the weight of your food. The automatic program then determines the optimum setting.

Setting a program

1. In waiting state, touch the A button twice to enter the auto menu function. The first program number will blink on the screen.
2. Touch - /+ or use the slider to select the program number you are after, as per the programs table on this page.
3. Touch the  button.
4. Touch the - /+ or use the slider to set the weight of the food you are heating and the cooking time will display on the screen.
5. Touch the  button to start the program. You will see the timer start counting down.

Changing the cooking time

If using automatic programs, you cannot change the cooking time .

Program has ended

A signal will sound and the oven will stop heating.

Changing the program

Once you have started the program the time or weight setting can not be changed.

Canceling a program

Touch the  button to cancel operation.

Program no.	Item	Weight(g)
P 01**	Fresh vegetables	200
		400
		600
P 02**	Potatoes peeled/cooked	240
		480
		720
P 03	Baked potatoes	450
P 04	Chicken pieces(frozen)	1000
P 05*	Cake	400
		500
		600
P 06*	Apple pie	2400
P 07*	Quiche	1000
P 08**	Reheat soup	200
		400
		600
P 09**	Reheat plate	250
		350
P 10**	Reheat sauce/stew	100
		200
		300
P 11	Frozen Pizza	200
		400
		600
P 12*	Frozen oven chips	300
		400
		500
P 13	Lasagna	1600



Notes

- The program with an * are preheated. During the preheating time the cooking timer is paused and the preheat symbol will be displayed. After preheating is done you will hear an alarm and the preheating symbol will blink.
- The programs with ** use only the microwave function.

Operation Instructions (Continued)

DEFROSTING PROGRAMS

You can use the three defrosting programs to defrost meat, poultry and bread.

1. In waiting state, touch the A key once to enter the defrost function. The first program number appears on the screen.
2. Touch - /+ or use the slider to select the program number.
3. Touch the  button.
4. Touch the - /+ or use the slider to set the weight of the food you are heating and the cooking time will display on the screen.
5. Touch the  button to start the program. You will see the timer start counting down.

Notes

- **Preparing food**
Use food that has been frozen at -18 °C and stored in portion sized quantities that are as thin as possible. Take the food to be defrosted out of all packaging and weigh it. You need to know the weight to set the program.
- Liquid will be produced when defrosting meat or poultry. Drain off this liquid when turning meat and poultry and under no circumstances use it for other purposes or allow it to come into contact with other foods.
- **Ovenware**
Place the food in a microwaveable shallow dish, e.g. a china or glass plate, but do not cover.
- When defrosting chicken and chicken portions (d 01), an audible signal will sound on two occasions to indicate that the food should be turned.
- **Resting time**
The defrosted food should be left to stand for an additional 10 to 30 minutes until it reaches an even temperature. Large pieces of meat require a longer standing time than smaller pieces. Flat pieces of meat and items made from minced meat should be separated from each other before leaving to stand. After this time, you can continue to prepare the food, even though thick pieces of meat may still be frozen in the middle.

Program no.	Defrost	Weight range in kg
d 01*	meat	0.10 - 1.50
d 02*	poultry	0.10 - 1.50
d 03*	fish	0.10 - 0.80





*During defrosting, place the food on the glass tray.

*If you hear 3 beeps, turn the food over.

Then touch start key to continue defrost.

PRESET COOKING

The appliance can be programmed to preset the cooking end time and duration.

1. In waiting state, touch the  button. The symbol will light up in the display and the hour figure will flash.
2. Touch the $-/+$ button or use the slider to adjust the hour figure between 0–23.
3. Touch  to confirm. The minute figures will flash.
4. Touch the $-/+$ button or use the slider to adjust the minute figure between 0–59.
5. Touch  to finish setting the preset time.
6. Set the type of heating and temperature you require.
7. Touch  to finish the setting.

The preset time has elapsed

An audible signal sounds. The oven starts cooking.

Note: Before setting the preset cooking, the clock must have been set. Kitchen Timer can not be set after the preset cooking setting.

TIME SETTING OPTIONS

Your oven has various time setting options. A time setting that has already been set can be changed directly using the parameter controls.

Setting the cooking time

The cooking time for your meal can be set on the oven using the  button. When the cooking time has elapsed, the oven switches itself off automatically. This means that you do not have to interrupt other work to switch off the oven. The cooking time cannot be accidentally exceeded.

The oven starts. The cooking time counts down in the display.

The cooking time has elapsed



An audible signal sounds. The oven stops heating.

Setting the clock

Refer to *Before using the appliance for the first time*.

Setting the timer

You can use the timer as a kitchen timer. It runs independently to the oven. The timer has its own audible signal. In this way, you can tell whether it is the timer or a cooking time which has elapsed.

1. In waiting state. Touch the  to enter kitchen timer. "00:00" will flash.
2. Touch $-/+$ or the slider to set the desired timer time.
3. Touch  to start the timer.

CHILD LOCK

The oven has a childproof lock to prevent children switching it on accidentally. The oven will not react to any settings. The timer and clock can also be set when the childproof lock has been switched on.

Turning on the Child lock

In waiting state, touch and hold the  button for 3 seconds. There will be a long beep and the lock symbol will appear in the display. The lock is now activated.

Switching off Child lock

In locked state, touch and hold the  button for 3 seconds. There will be a long beep and the lock symbol will disappear from the display. The lock is now off.

Installation Instructions

WARNING This user manual must be read! The laws, ordinances, directives and standards in force in the country of use are to be followed (safety regulations, proper recycling in accordance with the regulations, etc.)

IMPORTANT!

Installation must only be carried out by a qualified electrician. The minimum distances to other appliances and units are to be observed.

INSTALLATION REQUIREMENTS

- This appliance is only intended to be built-in.
- This appliance is not designed to be used as a tabletop appliance or inside a cupboard.
- The cabinetry that the appliance is being built-in must not have a back wall behind the appliance.
- A gap of at least 45 mm must be maintained between the wall and the base or back panel of the unit above.
- The cabinetry must have a ventilation opening of 250 cm² on the front. To achieve this, cut back the base panel or fit a ventilation grille.
- Ventilation slots and intakes must not be covered.
- The safe operation of this appliance can only be guaranteed if it has been installed in accordance with these installation instructions.
- The fitter is liable for any damage resulting from incorrect installation.
- The units into which the appliance is fitted must be heat-resistant up to 90°C.

INSTALLATION OPENINGS

Ventilation openings

behind, min. 250 cm²

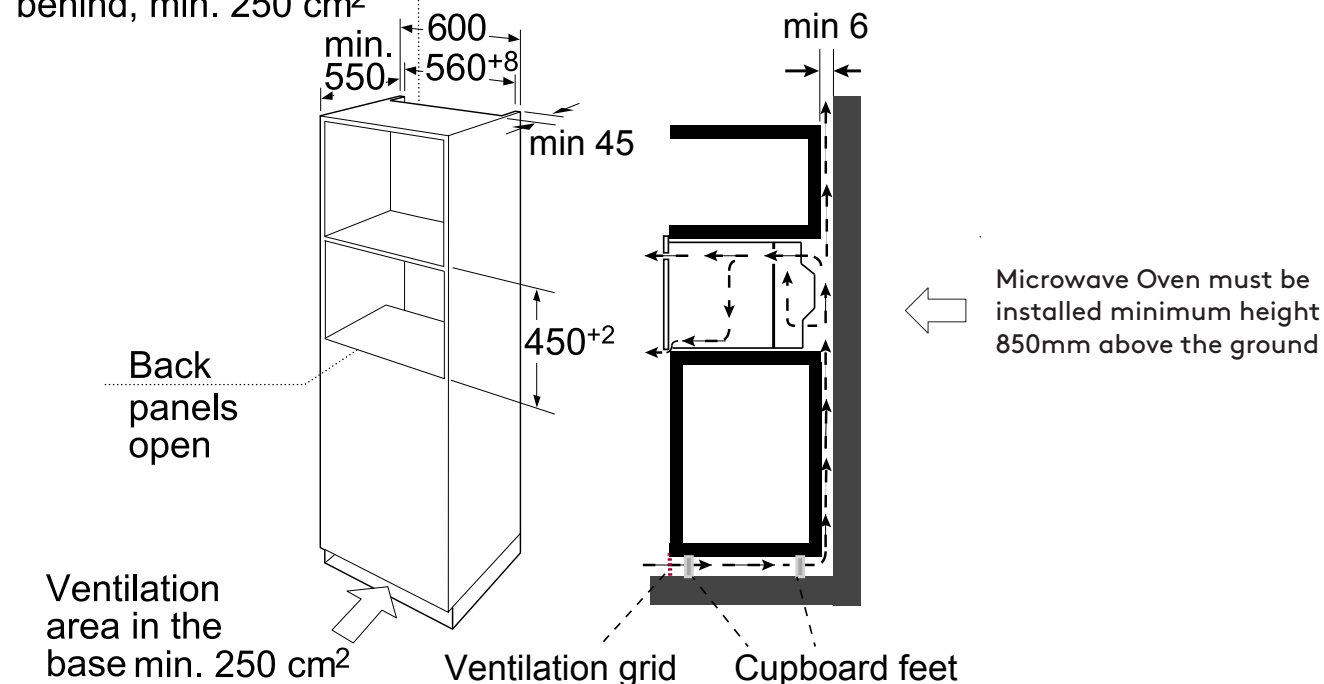

Note: There should be gap above the oven.

INSTALLATION

Do not hold or carry the appliance by the door handle. The door handle cannot hold the weight of the appliance and may break off.

1. Carefully remove the microwave from its box and slide it fully into the cavity, ensuring it is in the centre. Make sure you do not kink the power cable.
2. Open the door and fasten the appliance with the screws that were supplied.

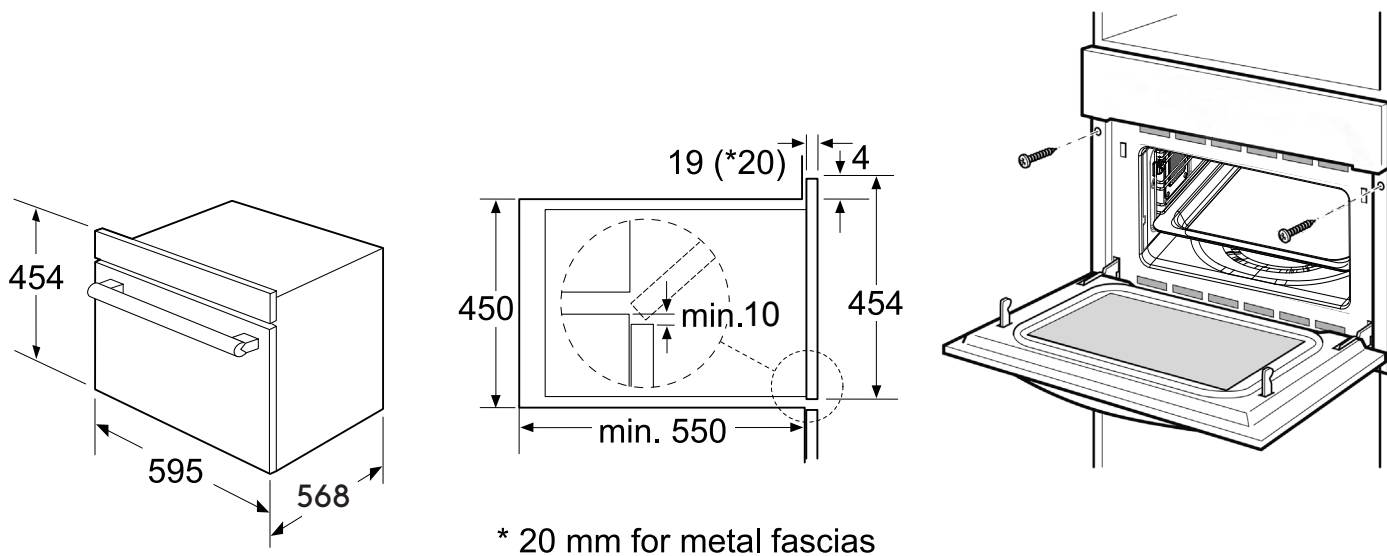

Important Information

The appliance is designed to be permanently installed with a three pin power cord and must only be connected by a licensed service technician in accordance with the wiring diagram.

Only a qualified electrician who takes the relevant regulations into account may replace the power cord.

Do not use multiple plugs, power strips or extensions. Overloading causes a risk of fire.

If the connection is no longer accessible following installation, an all pin isolating switch with a contact gap of at least 3mm must be provided.

Connect the wires to the mains power cord in accordance with the following colour coding;

Green and Yellow	Earth Wire (E)
Blue	Neutral Wire (N)
Brown	Live (L)

Great Britain and Australia

Do not connect the appliance using a 13A plug or protect it with a 13A fuse. The appliance must be protected using a fuse that is rated 16A or higher. The appliance must be disconnected from the power supply during all installation work. When the appliance is installed, protection must be provided against accidental contact in the future.

Installation Instructions (Continued)

INSTALLING THE HOOKS AND RAIL BRACKETS

1. Install the four hooks by following the steps below.
 - (a) First, install the hook into the hole a
 - (b) Then, push the hook into the hole b
 - (c) Finally, push the hook down to sit in place

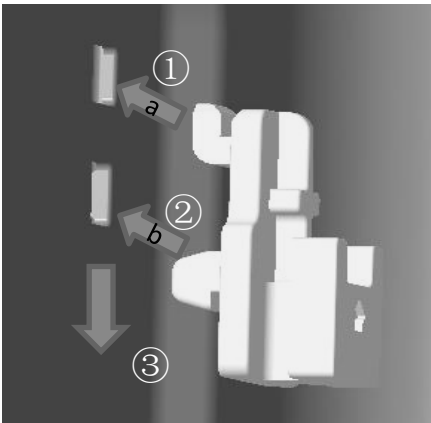

2. Get the left and right rail brackets.

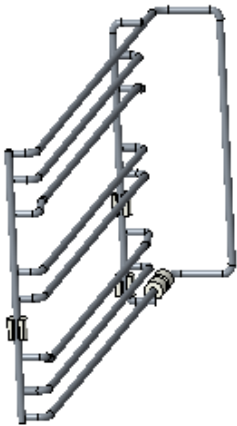

LEFT

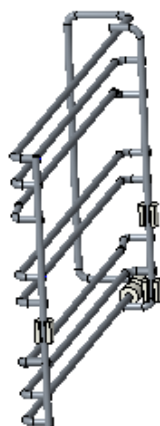

RIGHT

3. Install the left and right rail brackets by following the steps outlined below (for Left Bracket).
 - (a) Take the rail bracket up along the left groove of the hook.

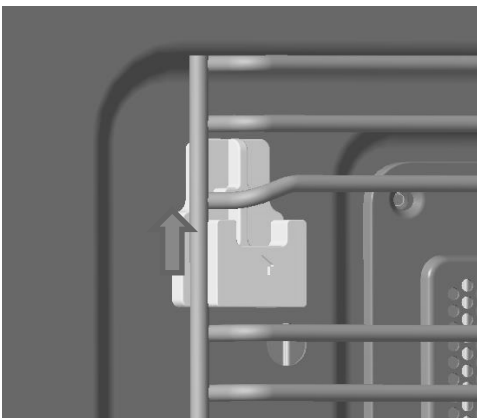

- (b) Move the rail bracket right, as shown below.

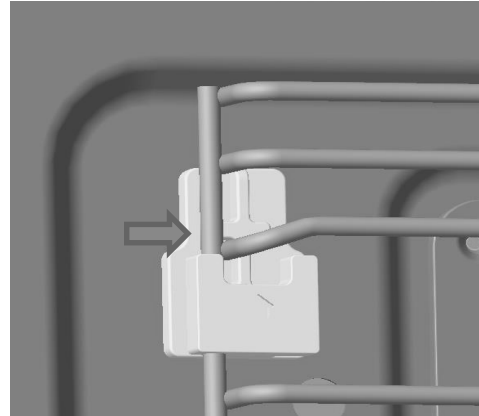

- (c) Move the rail bracket down into the bottom of the groove hook.

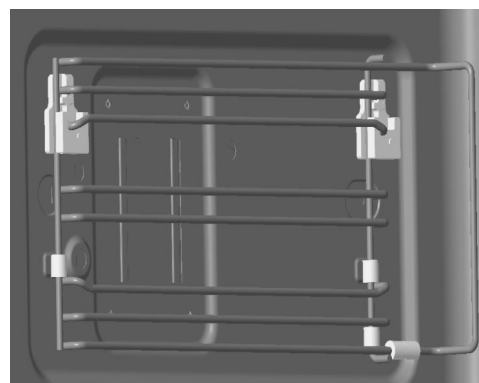
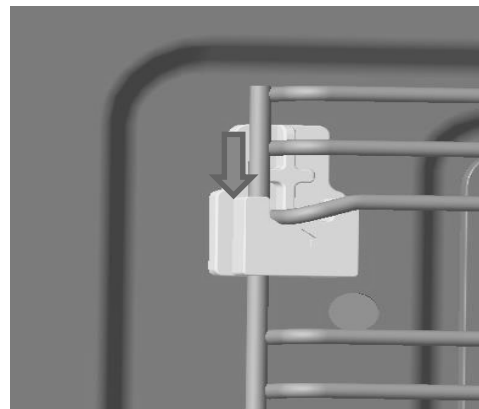

THIS PAGE IS INTENTIONALLY LEFT BLANK

Cleaning & Maintenance

With careful care and cleaning your microwave oven will retain its looks and remain good order. We will explain here how you should care for and clean your appliance correctly.

Risk of electric shock!

Penetrating moisture may cause an electric shock. Do not use any high-pressure cleaners or steam cleaners.

Risk of burns!

Never clean the appliance immediately after switching off. Let the appliance cool down.

Risk of serious damage to health!

Microwave energy may escape if the cooking compartment door or the door seal is damaged. Never use the appliance if the cooking compartment door or the door seal is damaged. Contact the after-sales service.

Notes

- Slight differences in colour on the front of the appliance are caused by the use of different materials, such as glass, plastic and metal.
- Shadows on the door panel which look like streaks, are caused by reflections made by the oven light.
- Unpleasant odours, e.g. after fish has been prepared, can be removed very easily. Add a few drops of lemon juice to a cup of water. Place a spoon into the container as well, to prevent delayed boiling. Heat the water for 1 to 2 minutes at maximum microwave power.

Cleaning agents

To ensure that the different surfaces are not damaged by using the wrong cleaning agent, observe the information in the table. Do not use;

- sharp or abrasive cleaning agents,
- metal or glass scrapers to clean the glass in the appliance door.
- metal or glass scrapers to clean the door seal,
- hard scouring pads and sponges,
- cleaning agents with high concentrations of alcohol.

Wash new sponge cloths thoroughly before use.

Allow all surfaces to dry thoroughly before using the appliance again.

HOW TO CLEAN VARIOUS OVEN COMPONENTS

Appliance front

Hot soapy water: Clean with a dish cloth and dry with a soft cloth. Do not use glass cleaners or metal or glass scrapers for cleaning.

Appliance front with stainless steel

Hot soapy water: Clean with a dish cloth and dry with a soft cloth. Remove flecks of limescale, grease, starch and albumin (e.g. egg white) immediately. Corrosion can form under such residues. Special stainless steel cleaning agents can be obtained from the after-sales service or from specialist shops. Do not use glass cleaners or metal or glass scrapers for cleaning.

Cooking compartment

Hot soapy water or a vinegar solution: Clean with a dish cloth and dry with a soft cloth.

If the oven is very dirty: Do not use oven spray or other aggressive oven cleaners or abrasive materials. Scouring pads, rough sponges and pan cleaners are also unsuitable. These items scratch the surface. Allow the interior surfaces to dry thoroughly.

Recess in cooking compartment

Damp cloth: Ensure that no water seeps through the turntable drive into the appliance interior.

Wire racks

Hot soapy water: Clean using stainless steel cleaning agent or in the dishwasher.

Door panel

Glass cleaner: Clean with a dish cloth. Do not use a glass scraper.

Seal

Hot soapy water: Clean with a dish cloth, do not scour. Do not use a metal or glass scraper for cleaning.

Troubleshooting

Some minor faults can be fixed by referring to the instructions given below. Please do not disassemble the unit by yourself to avoid any dangers and damages to yourself or the appliance. Instead contact our customer care team on **1300 11 4357** or visit our self help portal online at www.support.residentiagroup.com.au.

CAUTION! Risk of electric shock!

Repairs can be dangerous if done incorrectly. Repairs may only be carried out by a qualified service technician.

Problem	Possible Cause	Remedy
The appliance does not work.	<ul style="list-style-type: none"> Faulty circuit breaker. Plug not plugged in. Power cut. 	<ul style="list-style-type: none"> Have your installer check their connection. Check the mains fuse box to ensure a fuse has not been tripped or blown. Plug in the plug. Check if the light works.
The appliance does not work and the lock symbol appears on the display.	<ul style="list-style-type: none"> Child lock is on. 	<ul style="list-style-type: none"> Deactivate child lock as per the instructions in this manual.
The microwave will not switch on.	<ul style="list-style-type: none"> Door not fully closed. 	<ul style="list-style-type: none"> Check if there is anything blocking the door from closing.
It takes longer than usual for food to heat up in the microwave.	<ul style="list-style-type: none"> The selected microwave power is too low. A larger amount of food has been placed in the microwave. The food was colder than usual. 	<ul style="list-style-type: none"> Select a higher power level. Double the amount of food equals double the amount of cooking time Stir or turn the food during cooking.
A particular operating mode or power level cannot be set.	<ul style="list-style-type: none"> The temperature, power level or combined setting is not allowed for this mode. 	<ul style="list-style-type: none"> Choose permitted settings.
E-01 appears on the display.	The thermal safety switch-off function has been activated.	Call the Customer Care team.
E-04 appears on the display.	The thermal safety switch-off function has been activated.	Call the Customer Care team.
E-17 appears on the display.	Rapid heating has failed.	Call the Customer Care team.

Energy Saving Tips

- Only preheat the oven if this is specified in the recipe or in the operating instruction tables.
- Use dark, black lacquered or enameled baking tins. They absorb the heat particularly well.
- Open the oven door as infrequently as possible while you are cooking, baking or roasting.
- If you need to bake several items it is best to bake them one after another as the oven will still be warm. Alternatively you could place items next to each other if there is space and they have similar cooking requirements.
- For longer cooking times, you can switch the oven off 10 minutes before the end of the cooking time and use the residual heat to finish cooking.

INFORMATION ON DISPOSAL FOR USERS

- Most of the packaging materials are recyclable. Please dispose of these materials through your local recycling depot or by placing them in appropriate collection containers.
- If you wish to discard this product, please contact your local authorities and ask for the correct method of disposal.

Technical Specifications

MODEL	IOMC6013T
RATED VOLTAGE	220-240V~ 50Hz
MAXIMUM POWER	3350W
RATED OUTPUT POWER (MICROWAVE)	900W
RATED CURRENT	15A
OVEN CAPACITY	50L
PRODUCT DIMENSIONS (Excluding handle)	595(W) × 568(D) × 454(H)mm

Purchase Details

For future reference, please record the following information in the form below. The product details can be found on the rating plate, and purchase details which can be found on your sales invoice.

STORE DETAILS

STORE NAME | _____

ADDRESS | _____

TELEPHONE | _____

PURCHASE DATE | _____

PRODUCT DETAILS

MODEL NO. | _____

SERIAL NO.* | _____

Attach your receipt
to this page



Warranty Information

AUSTRALIAN WARRANTY TERMS & CONDITIONS COOKING APPLIANCES

This document sets out the terms and conditions of the product warranties for Residentia Group Appliances. It is an important document. Please keep it with your proof of purchase documents in a safe place for future reference should you require service for your Appliance.

1. IN THIS WARRANTY

- (a) 'acceptable quality' as referred to in clause 10 of this warranty has the same meaning referred to in the ACL;
 - (b) 'ACL' means Trade Practices Amendment (Australian Consumer Law) Act (No.2) 2010;
 - (c) 'Appliance' means any Residentia Group product purchased by you accompanied by this document;
 - (d) 'ASR' means Residentia Group authorised service representative;
 - (e) 'Residentia Group' means Residentia Group Pty Ltd of 165 Barkly Avenue Burnley VIC, ACN 600 546 656 in respect of Appliances purchased in Australia;
 - (f) 'major failure' as referred to in clause 10 of this warranty has the same meaning referred to in the ACL and includes a situation when an Appliance cannot be repaired or it is uneconomic for Residentia Group, at its discretion, to repair an Appliance during the Warranty Period;
 - (g) 'Warranty Period' means:
 - (i) where the Appliance is used for personal, domestic or household use (i.e. normal single family use) as set out in the instruction manual, the Appliance is warranted against manufacturing defects for 24 months (or 36 months where a valid extended warranty registration has occurred), following the date of original purchase of the Appliance;
 - (h) 'you' means the purchaser of the Appliance not having purchased the Appliance for re-sale, and 'your' has a corresponding meaning.
2. This warranty only applies to Appliances purchased and used in Australia and is in addition to (and does not exclude, restrict, or modify in any way) any non-excludable statutory warranties in Australia.
 3. During the Warranty Period Residentia Group or its ASR will, at no extra charge if your Appliance is readily accessible for service, without special equipment and subject to these terms and conditions, repair or replace any parts which it considers to be defective. Residentia Group or its ASR may use remanufactured parts to repair your Appliance. You agree that any replaced Appliances or parts become the property of Residentia Group. This warranty does not apply to light globes, batteries, filters or similar perishable parts.
 4. Parts and Appliances not supplied by Residentia Group are not covered by this warranty.
 5. You will bear the cost of transportation, travel and delivery of the Appliance to and from Residentia Group or its ASR. If you reside outside of the service area, you will bear the cost of:
 - (a) travel of an authorised representative;
 - (b) transportation and delivery of the Appliance to and from Residentia Group or its ASR, in all instances, unless the Appliance is transported by Residentia Group or its ASR, the Appliance is transported at the owner's cost and risk while in transit to and from Residentia Group or its ASR.
 6. Proof of purchase is required before you can make a claim under this warranty.
 7. You may not make a claim under this warranty unless the defect claimed is due to faulty or defective parts or workmanship. Residentia Group is not liable in the following situations (which are not exhaustive):

- (a) the Appliance is damaged by:
- (i) accident
 - (ii) misuse or abuse, including failure to properly maintain or service
 - (iii) normal wear and tear
 - (iv) power surges, electrical storm damage or incorrect power supply
 - (v) incomplete or improper installation
 - (vi) incorrect, improper or inappropriate operation
 - (vii) insect or vermin infestation
 - (viii) failure to comply with any additional instructions supplied with the Appliance;
- (b) the Appliance is modified without authority from Residentia Group in writing;
- (c) the Appliance's serial number or warranty seal has been removed or defaced;
- (d) the Appliance was serviced or repaired by anyone other than Residentia Group, an authorised repairer or ASR.
8. This warranty, the contract to which it relates and the relationship between you and Residentia Group are governed by the law applicable where the Appliance was purchased.
9. To the extent permitted by law, Residentia Group excludes all warranties and liabilities (other than as contained in this document) including liability for any loss or damage whether direct or indirect arising from your purchase, use or non use of the Appliance.
10. For Appliances and services provided by Residentia Group in Australia, the Appliances come with a guarantee by Residentia Group that cannot be excluded under the Australian Consumer Law. You are entitled to a replacement or refund for a major failure and for compensation for any other reasonably foreseeable loss or damage. You are also entitled to have the Appliance repaired or replaced if the Appliance fails to be of acceptable quality and the failure does not amount to a major failure. The benefits to you given by this warranty are in addition to your other rights and remedies under a law in relation to the Appliances or services to which the warranty relates.
11. At all times during the Warranty Period, Residentia Group shall, at its discretion, determine whether repair, replacement or refund will apply if an Appliance has a valid warranty claim applicable to it.
12. Missing parts are not covered by warranty. Residentia Group reserves the right to assess each request for missing parts in a case by case basis. Any parts that are not reported missing in the first week after purchase will not provide free of charge.
13. To enquire about claiming under this warranty, please follow these steps:
- (a) carefully check the operating instructions, user manual and the terms of this warranty;
 - (b) have the model and serial number of the Appliance available;
 - (c) have the proof of purchase (e.g. an invoice) available;
 - (d) telephone the numbers shown below.
14. You accept that if you make a warranty claim, Residentia Group and its ASR may exchange information in relation to you to enable Residentia Group to meet its obligations under this warranty.
- IMPORTANT**
Before calling for service, please ensure that the steps in point 13 have been followed.
- Telephone contact
- Service: Please call 1300 11 HELP (4357)

The Australian Consumer Law requires the inclusion of the following statement with this warranty:
Our goods come with guarantees that cannot be excluded under the Australian Consumer Law. You are entitled to a replacement or refund for a major failure and for compensation for any other reasonably foreseeable loss or damage. You are also entitled to have the goods repaired or replaced if the goods fail to be of acceptable quality and the failure does not amount to a major failure.

THIS PAGE IS INTENTIONALLY LEFT BLANK

Warranty Information (Continued)

NEW ZEALAND WARRANTY TERMS & CONDITIONS COOKING APPLIANCES

To help care for your investment, be sure to register your appliance online. Registration will help you if you need to arrange service in the future, and serves as a record of your purchase – including critical information like model number and serial number – that you can refer to at any time.

Simply visit the below website, or ask your retailer for help: www.inalto.house/nz/registration

WARRANTY:

These products are covered by a warranty for a period of 24 months from the date of purchase, subject to the following conditions*. The warranty covers rectification free of charge of any fault arising from defective materials or components, or faulty workmanship or assembly.

* The conditions above mentioned are:

1. That the purchaser carefully follows all instructions packed with the product;
2. That the purchaser and/or installer carefully follows the installation instructions provided and complies with electrical wiring regulations, gas and/or plumbing codes;
3. That the purchaser carefully follows instructions provided in the owner's handbook relating to the proper use and care of the product and does not use the product for any purpose other than the domestic use for which it has been designed;
4. Commercial use of the product for professional or industrial purposes will void this warranty.;
5. That the product was purchased and installed in New Zealand;
6. That this warranty does not extend to:
 - a) optional glass lids for hobs apart from claims which relate to mechanical or physical damage thereof at the date of purchase;
 - b) 'consumable' parts such as light bulbs or filters;
 - c) damage to ceramic glass caused by liquid or solid spill-overs, lack of maintenance, or impact;
 - d) damage to surface coatings caused by cleaning or maintenance using products not recommended by the owner's handbook;
 - e) defects caused by normal wear and tear, accident, negligence, alteration, misuse or incorrect installations;
 - f) a product dismantled, repaired or serviced by any serviceman other than an authorised service agent;

- g) a product not in possession of the original purchaser;
- h) damage caused by power outages or surges
- i) damage caused by pests (eg. rats, cockroaches etc.)

7. That if the product is a freestanding microwave oven or small appliance it must be returned to the dealer/retailer for servicing. These products, unless stated otherwise, have a 12 month warranty from original date of purchase with 24 months on the microwave magnetron; Waste disposers have a 12 month warranty.
8. The provision of service under this warranty is limited by a 25km boundary from the retailer where the product was purchased except for microwaves. Such travelling outside of these limits will incur commercial cost to be paid by you, regulated by the number of kilometres travelled beyond the 25km limit (50km return trip). Microwaves are to be delivered to the nearest authorised service agent by the customer.

Please refer to your user manual for any further conditions that may apply to your specific model.

Nothing herein contained shall be construed in any way as excluding or limiting your rights under the Consumer Guarantees Acts 1993.

For Service please visit www.applico.co.nz/service or contact the dealer/retailer from whom you purchased the product from or call the 0800 number listed below. If you are unable to establish the date of purchase, or the fault is not covered by this warranty, or if the product is found to be in working order, you will be required to bear all service call charges.

Registration of this warranty constitutes acceptance of the terms and conditions of this warranty.

Should you require any assistance, please call Customer Services on 0800 763 448.

Distributed by Applico Ltd.
www.applico.co.nz
July 2019

After registering your appliance online, we recommend you fill out the below information for your reference and keep this warranty card in a safe place.

THIS WARRANTY IS VALID IN NEW ZEALAND ONLY.

DESIGNED IN MELBOURNE

INALTO

FOR ALL AUSTRALIAN HOMES

WWW.INALTO.HOUSE



E2447